

Universal dimmer JB525C23

5WG1525-4CB23

April 2020 / Page 1



Product and Applications Description

The JB525C23 Universal Dimmer is a KNX device with one dimmer output. The device is installed in a 4 x 4 inch junction box. The bus is connected via a bus terminal block. The actuator electronics are supplied via the bus voltage.

The JB525C23 can switch and dim resistive loads (e.g. incandescent lamps, high voltage halogen lamps), capacitive loads (e.g. low voltage halogen lamps with intermediate electronic transformers), or inductive loads (e.g. low voltage halogen lamps with intermediate conventional transformers).

Protection against over-load / short-circuit

After about 5 seconds in an over-load condition the universal dimmer turns itself off permanently. At the earliest 2 minutes after an over-load or short-circuit tripping the dimmer may be turned on again. First send an "off" or a "dimming value =0" command to turn the device off and then turn it on again by sending an "on" or a "dimming value > 0" command.

In a short-circuit condition the dimmer turns the load off for 3 seconds and, within 1 minute, once automatically tries to switch the output on to the currently set dimming value. If the short-circuit condition still persists the output is turned off permanently.

Turn the output on again by following the instructions for a permanently turned off output in an over-load condition.

Protection against over-temperature

In case the maximum permissible temperature is exceeded the dimmer dims down to the minimal dimming value. If after 2 minutes the dimmer has cooled down sufficiently, it automatically dims back to the currently set dimming value. If after 2 minutes the maximum permissible over-temperature is still exceeded, the output is turned off permanently.

Turn the output on again by following the instructions for a permanently turned off output in an over-load condition.

Application Program

The JB525C23 Universal dimmer needs the application program "07B0 A1 Universal dimmer 982C01".

Example of Operation

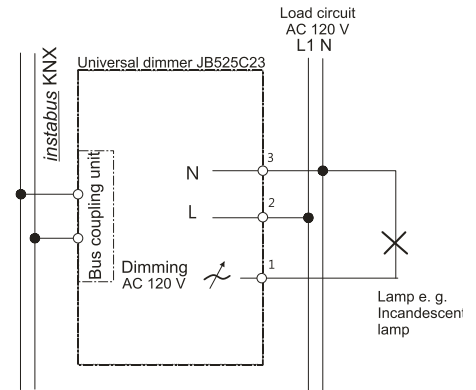

Technical Specifications

Power supply

- via the bus line
- KNX bus voltage: DC 24V (DC 21...30V) via KNX/EIB bus line
- KNX bus current: < 10 mA

Output

- rated voltage: AC 120 V, 50/60 Hz
- rated current: 1.1A
- rated power at 35°C ambient temperature: 10...130 VA (inductive)
10...120 VA (capacitive)
5 ... 120 W (resistive)
- maximum power of devices connected in relation to the ambient temperature:

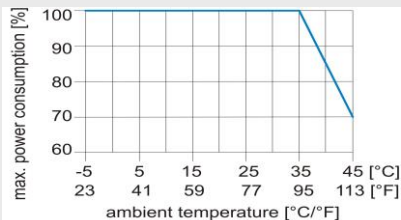

Control elements

1 learning button: for switching between normal operating mode and addressing mode

Display elements

1 red LED: for monitoring bus voltage and for displaying normal mode/addressing mode

Connections

- Bus line : Bus connection pins for connection of the screwless bus terminal block (red-black) 0.6...0.8 mm Ø single core, strip insulation 5mm
- Load circuit: see Location and Function of Interface Elements

Physical specifications

- housing: plastic
- dimensions (L x W x D):
length : 70 mm (2.76 inch)
width : 90 mm (3.54 inch)
depth: 44.6 mm (1.76 inch)
- weight: approx. 180 g
- fire load: approx. 5 MJ
- Installation: in a junction box (min. dimensions (L-W-D))
Length: 4 inch (101.6 mm)
Width: 4 inch (101.6 mm)
Depth: 2 inch (50.8 mm)

Electrical safety

- Degree of pollution (according to IEC 60664-1): 2
- Type of protection (according to EN 60529): IP 20
- Overvoltage category (according to IEC 60664-1): III
- Bus: safety extra low voltage SELV DC 24 V
- Device complies with: EN 50428

Electromagnetic compatibility

complies with EN 50428

Environmental specifications

- Ambient operating temperature:
-5 ... + 45 °C (+ 23 ... + 113 °F)
- Storage temperature:
- 25 ... + 70 °C (- 13 ... + 158 °F)
- Relative humidity (not condensing): 5 % ... 93 %

Reliability

- Failure rate: 408 fit at 40°C

Markings

EIB, KNX, UL

Listings and Certifications

CE mark

complies with the EMC regulations (residential and functional buildings) and low voltage regulations

UL listed (E464611)

UL 916, Open Energy Management Equipment

Note:

- The device must be mounted and commissioned by an authorized electrician.
- A safety disconnection of the device must be possible.
- The device must not be opened.
- Use only transformers that allow dimming operations.
- Conventional transformers may be used, if they have a thermic fuse.
- Running magnetic transformers at no load is prohibited both on start-up and in operation, because this may lead to damage to the device (even when the dimmer has cut off). This is to be ensured by connecting at least two lamps or transformers in parallel to an output. Failed lamps are to be replaced immediately.
- Connecting inductive and capacitive or resistive loads at the same time to the same dimmer output is not permitted and leads to damage or destruction of the universal dimmer!**

Location and Function of the Interface Elements

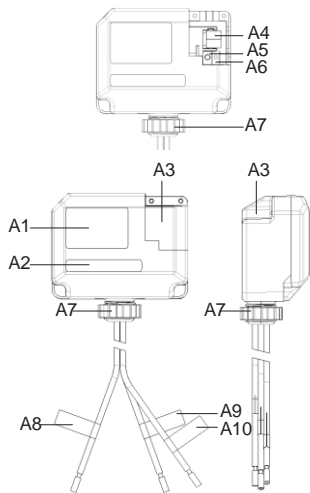

- A1 Type label (with space for physical address of the device)
- A2 Identification number of the device
- A3 Protective lid over bus connection
- A4 Bus connection terminal block for single core conductors with 0.6...0.8 mm Ø
- A5 LED for indicating normal operating mode (LED off) or addressing mode (LED on); returns to normal operating mode automatically after receiving the physical address
- A6 Learning button for switching between normal operating mode and addressing mode for receiving the physical address
- A7 1/2 inch screw nut
- A8 Wire (red) Load A (AWG #14)
- A9 Wire (black) Line (Hot) (AWG #14)
- A10 Wire (white) Neutral (AWG #14)

Dimension Diagram

Dimensions in mm (inch)

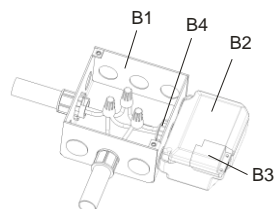
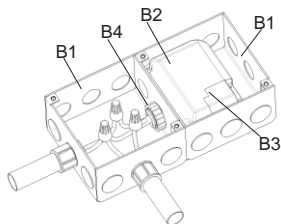
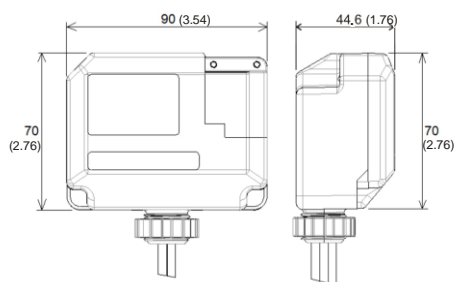

- B1 4" x 4" Junction Box
- B2 Device
- B3 Bus connection pins of the module for connection of the bus terminal block for single core conductors with 0.6...0.8 mm Ø
- B4 1/2 inch screw nut

Mounting and Dismounting

- Mounting of a JB module:
 - Option 1 (mounting inside a J-Box)
 - Insert the thread of the JB module (B2) into the 1/2 inch knockout between two adjacent J-Boxes (B1)
 - Fasten the JB module (B2) with the 1/2 inch thread nut (B4)
 - Remove the protective lid (B3) and connect the bus wire to the bus terminal block (A4)
 - Connect the wires from the device to the field wires using wire nuts (not provided in package)
 - Option 2 (mounting outside of a J-Box)
 - Insert the thread of the JB module (B2) into the 1/2 inch knockout of the J-Box (B1)
 - Fasten the JB module (B2) with the 1/2 inch thread nut (B4) to the J-Box (B1)
 - Connect the bus wire to the bus terminal block under the protective cover (B3)
 - Connect the wires from the device to the field wires using wire nuts (not provided in package)
- Assignment of the Physical Address:
 - A short push (< 2 s) of learning button (A6) enables the addressing mode, which is indicated when the LED is continuously on (A5). The device returns to normal operating mode (LED Off) automatically after receiving the physical address or if the learning button is pushed again.
 - A very long push (> 20 s) of the learning button resets the device to factory settings. This is indicated by constant flashing for 8 seconds.
 - A long push (> 5 s up to 20 s) of the learning button enables the Connection Test for commissioning with Desigo. This mode can be disabled by a short push any time.
 - Install the protective lid (B3) and fasten with screws (provided in package)
- Dismounting a JB module:
 - Disconnect power to the module
 - Remove the wire nuts and bus connection
 - Unfasten the 1/2 inch thread nut (B4) connecting the JB module (B2) to the J-Box (B1)
 - Remove the JB module (B2) from the J-Box (B1)

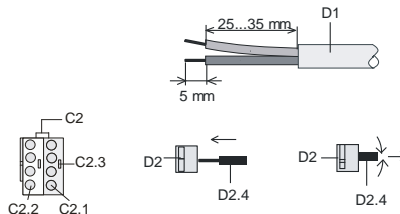

Wiring

Slipping off/on bus connection blocks
The bus connection block consists of two components (C2.1 and C2.2) with four terminal contacts each. Take care not to damage the two test sockets (C2.3) by accidentally connecting them to the bus cable or with the screw driver (e.g. when attempting to unplug the bus connection block).

- Slipping off bus connection blocks
 - Carefully put the screw driver to the wire insertion slit of the bus connection block's grey component (C2.2) and
 - pull the bus connection block (C2) from the module.

WARNING

Hazardous voltage.
Can cause death, or serious injury or property damage.

The device must not be opened.
A faulty device should be returned to the local Siemens sales office or distributor.

The device must be mounted and commissioned by a factory trained person.
The prevailing safety rules must be observed!
Mount in dry locations only!

Note

Don't try to remove the bus connection block from the bottom side. There is a risk of shorting-out the device!

Slipping on bus connection blocks

- Slip the bus connection block (C2) onto the guide slot of the module and
- press the bus connection block (C2) down to the stop.

Connecting and Disconnecting bus cables

Connecting bus cables

- The bus connection block (D2) can be used with single core conductors Ø 0.6...0.8 mm.
- Remove approx. 5 mm of insulation from the conductor (D1) and plug it into the bus connection block (D2) (red = +, grey = -)

Disconnecting bus cables

- Unplug the bus connection block (D2) and remove the bus cable conductor (D1) while simultaneously wiggling it.

Connecting mains and load circuit:

Connect wires

- Connect wire leads using wire nuts

Electromagnetic compatibility

USA:

This device complies with part 15 of the FCC Rules. Operation is subject to the following two conditions:

- (1) This device may not cause harmful interference, and
- (2) This device must accept any interference received, including interference that may cause undesired operation.

This equipment has been tested and found to comply with the limits for a Class B digital device, pursuant to part 15 of the FCC Rules. These limits are designed to provide reasonable protection against harmful interference in a residential installation. This equipment generates, uses and can radiate radio frequency energy and, if not installed and used in accordance with the instructions, may cause harmful interference to radio communications. However, there is no guarantee that interference will not occur in a particular installation. If this equipment does cause harmful interference to radio or television reception, which can be determined by turning the equipment off and on, the user is encouraged to try to correct the interference by one or more of the following measures:

- Reorient or relocate the receiving antenna.
- Increase the separation between the equipment and receiver.
- Connect the equipment into an outlet on a circuit different from that to which the receiver is connected.
- Consult the dealer or an experienced radio/TV technician for help.

This device complies with Part 15 of the FCC rules. Changes or modifications not expressly approved by Siemens Schweiz AG could void the user's authority to operate the equipment.

United States representative:

<https://new.siemens.com/us/en/products/buildingtechnologies/home.html>

Canada:

CAN ICES-3(B)/NMB-3(B)