

07 B0 KNX / DALI Gateway Twin N 141/31 983D11
 07 B0 KNX / DALI Gateway Twin plus N 141/21 983411
 07 B0 KNX / DALI Gateway plus N 141/03 983711

Contents

1. Product description	6
1.1 DALI fundamentals	6
1.2 DALI-2 fundamentals	6
1.3 Gateway fundamentals	6
2. Functional overview of all devices	7
2.1 Modes	7
2.2 Replace defective DALI-ECGs	9
2.3 Failure messages on info display	10
2.4 Objects for device and channels	11
2.5 Objects for groups	12
2.6 Scene control (8-bit)	13
3. Selectable functions	14
3.1 Sensors	14
3.2 ECG	14
3.3 2-point lighting control	14
3.4 Constant lighting control	14
3.5 Stand-by	14
3.6 Timer	14
3.7 Effect control (Sequencer)	14
3.8 Burn-in function (Complete system)	14
3.9 Burn-in function via object	15
3.10 Emergency mode	17
3.11 Standard applications	19
4. Modes	20
4.1 Normal mode (bus mode)	20
4.2 Central commands (Broadcast)	20
4.3 Direct mode	20
4.4 Standalone mode	22
4.5 Night mode	23
5. ETS application program	24
5.1 Parameter windows	24
5.2 Menu bar	25
5.3 Overview	27
5.4 Parameter windows	27
5.5 Transferring parameters	27
6. Communication objects	28
7. Status	29
7.1 View Status	29
7.2 View Status – Channel A (B)	31
8. Channel	32
8.1 Channel mode	32
8.2 Broadcast (Central function)	33
9. Groups	35
9.1 Parameter windows	35
9.2 Parameters for group	36
9.3 Objects per group	43
9.4 Parameter status messages	44
9.5 Objects status messages	47
9.6 Status /failure message	51
9.7 Disable failure status messages	51
10. ECG	52
10.1 Device parameters	53
10.2 Dimming behavior	55
10.3 Device type 0 - Fluorescent lamp	55
10.4 Device type 1 – Emergency light with single battery	56
10.5 Device type 8 - color control	63
10.6 Objects	64
10.7 Status/failure messages	65

07 B0 KNX / DALI Gateway Twin N 141/31 983D11
 07 B0 KNX / DALI Gateway Twin plus N 141/21 983411
 07 B0 KNX / DALI Gateway plus N 141/03 983711

11. Sensors	67
11.1 Overview	68
11.2 DALI binary input	70
11.3 Parameter - Input channels	71
11.4 DALI Presence detector	83
12. Stand-by	93
13. Scenes	95
14. Effects controller	99
14.1 Effects channels	99
14.2 Effects	101
14.3 Effect step	102
14.4 Objects and parameters	103
15. 2-point lighting control	104
15.1 Description	104
15.2 Objects	106
15.3 Behavior during emergency mode	107
16. Constant lighting control	108
16.1 Overview	108
16.2 Controller for a lighting group	109
16.3 Controller for multiple lighting groups	110
16.4 Parameter	114
16.5 Objects	119
16.6 Behavior during emergency mode	120
17. Timer function	121
17.1 Location and real time clock (RTC)	121
17.2 Channels	124
17.3 Switching points	125
17.4 Behavior during after-run	127
18. Failure status devices	128
18.1 Parameter	128
18.2 Power failure	128
18.3 DALI device failure	129
18.4 DALI short circuit	129
19. Export/Import/Convert	130
19.1 Overview	130
19.2 Export	130
19.3 Import	130
19.4 KNX converter library	130
19.5 GAMMA Converter App	131
20. Documentation	132
21. Commissioning	133
22. Test	140
22.1 Groups	140
22.2 ECG	141
22.3 Scenes	143
22.4 Effects	143
23. Settings	145
23.1 Works function	145
23.2 Acknowledge	145
23.3 Behavior during Download	145
24. Behavior during power failure/recovery	147
24.1 Parameter	147
24.2 Objects - Failure status	148
24.3 Group/ECG	149
24.4 Sensors	156
24.5 2-point controller/Constant light control	156
24.6 Timer functions	156
25. Standard applications	157
26. Annexes	171

07 B0 KNX / DALI Gateway Twin N 141/31 983D11
07 B0 KNX / DALI Gateway Twin plus N 141/21 983411
07 B0 KNX / DALI Gateway plus N 141/03 983711

26.1 DALI dimming curve	171
26.2 Color temperature control	171
26.3 Troubleshooting.....	172

07 B0 KNX / DALI Gateway Twin N 141/31 983D11
 07 B0 KNX / DALI Gateway Twin plus N 141/21 983411
 07 B0 KNX / DALI Gateway plus N 141/03 983711

Use of the application program

Product family: Lighting
 Product type: Interface
 Manufacturer: Siemens

Name: KNX/DALI Gateway Twin plus N 141/21
 Order no.: 5WG1141-1AB21

Name: KNX/DALI Gateway Twin N 141/31
 Order no.: 5WG1141-1AB31

Name: KNX/DALI Gateway plus N 141/03
 Order no.: 5WG1141-1AB03

The application description provides information on the full range of functions for the KNX/DALI Gateway Twin plus N 141/21 - 983411 (Firmware Version V15). The range of functions of N 141/03 - 983711 (Firmware version V15) is limited to channel A. Also N 141/31 - 983D11 (Firmware Version V15) is limited. For firmware V11 and later the range of functions of the N 141/31 is limited to the application program. This means that the DALI sensors and 2-point lighting control can only be used with the N 141/31 until firmware V06. Any existing configuration without DALI sensors or 2-point lighting control can be converted to 983D11. Then it can still be used with firmware V11 and later.

The functions common to all devices are described in Section 2 and the selectable functions in Section 3. The table 1 on the following page contains an overview of the functions for each KNX/DALI Gateway.

A new firmware can only if necessary be loaded to the gateway by KNX. For additional information, please see www.siemens.com/gamma-fdt

Enhancements in firmware V15 compared to firmware V12

A minor bug (see release notes) has been fixed.

Enhancements in application programs 983x11 and firmware V11/V12/V15 compared to application programs 983x06 and firmware V06

Color temperature control

Supports device type 8 - color temperature control for groups and ECG and integration in scenes, effect control and timer functions. **Improvements:**

The response once the download is complete can now be configured so that the lighting is not switched off.

The response after first switching on (power up) of the KNX/DALI GW has been modified. The lighting is switched on rather than switched off.

To enable longer names for DALI groups and ECG (up to 50 characters), a second field for 25 characters is always available. By automatic assignment of ECG: Once an ECG left has been assigned, the next ECG right is selected completely (light is flashing) so that it is no longer required to selected the ECG but only assigned to the left.

07 B0 KNX / DALI Gateway Twin N 141/31 983D11
 07 B0 KNX / DALI Gateway Twin plus N 141/21 983411
 07 B0 KNX / DALI Gateway plus N 141/03 983711

Productname	N 141/03 KNX/DALI Gateway plus		N 141/21 KNX/DALI Gateway Twin plus		N 141/31 KNX/DALI Gateway Twin	
MLFB	5WG1141-1AB03		5WG1141-1AB21		5WG1141-1AB31	
Application number	983706	983711	983406	983411	983D06	983D11
Firmware Version	V06	V11/V12/V15	V06	V11/V12/V15	V06	V11/V12/V15

DALI Channels	1		2		2	
ECG individual control	x	x	x	x	x	x
DALI sensors	x	x	x	x		
Emergency mode	x	x	x	x	x	x
Record of the emergency lights tests	x	x	x	x		
Constant lighting control	x	x	x	x		
2-point-lighting control	x	x	x	x		
Stand-by	x	x	x	x	x	x
Timer	x	x	x	x		
Effect control	x	X	x	x		
Scenes	16		16 per channel		16 per channel	
Burn-in function (complete system)	x	x	x	x		
Burn-in function via object	x	x	x	x	x	x
Pre-loaded applications	x	x	x	x		
Color temperature control		x		x		x

Table 1 Functions overview by KNX/DALI Gateway and application program

07 B0 KNX / DALI Gateway Twin N 141/31 983D11 07 B0 KNX / DALI Gateway Twin plus N 141/21 983411 07 B0 KNX / DALI Gateway plus N 141/03 983711
--

1. Product description

These KNX/DALI Gateways are KNX devices with one or two independent DALI interfaces. Up to 64 DALI actuators (e.g. ECG with DALI interface) and additional DALI sensors (e.g. DALI key interface, presence detectors, etc.) can be connected per channel.

The KNX/DALI Gateway is a DALI-2 certified device. It has successfully completed the DALI-2 certification process operated by DiiA. ***

1.1 DALI fundamentals

The universal DALI standard (DALI = Digital Addressable Lighting Interface) is a system for controlling electronic switching devices (ECG) in lighting systems. The DALI communication interface specification is set out in the international IEC 62386 standard.

DALI not only receives switching and dimming commands. Additionally, status information for lighting values or failure states, such as the failure of a light or an ECG, can be reported via DALI. Sensors with DALI interface are also supported. In a single DALI line, up to 64 individual DALI switching devices (slaves) can be connected through the associated controller/gateway (master). On DALI commissioning, ECGs receive an automatically generated address and in the further commissioning process a short address from 0...63 based on this address. As the address is assigned automatically, the equipment configuration is also random and the individual ECGs/lights must first be identified as the commissioning continues. Individual ECGs in the system are addressed either on the basis of the short address (individual controller) or on the basis of a DALI group address (group addressing). For this purpose, any number of ECG's in a line can be arranged in up to 16 DALI groups. The group addressing in the DALI system ensures that a system's different light switching and dimming processes are performed concurrently without any time differences.

In addition to the addressing through short addresses and group addresses, lighting values for individual DALI ECGs can also be aggregated in scenes and contacted via scene addressing.

You will find further information on DALI, for example in the DALI manual at: www.dali-alliance.org

1.2 DALI-2 fundamentals

The DiiA has a DALI-2 certification program, which aims to improve the interoperability between DALI devices. The KNX/DALI Gateway has successfully completed this DALI-2 certification process. ***

You will find further information on DALI-2 at: www.dali-alliance.org

1.3 Gateway fundamentals

The KNX/DALI Gateway communicates with up to 64 DALI actuators per channel. These can be connected and dimmed in up to 16 groups per channel and the color temperature can potentially be controlled. The gateway also supports selected sensors with DALI interface. It also records and transfers DALI status and failure messages. An individual name, a group, parameter and scenes are assigned to individual DALI ECG's during commissioning with the ETS (Engineering Tool Software). DALI sensors and their functionality are also assigned in the ETS.

All DALI subscribers and functions are independent and can be linked via group addresses.

The device can only be operated in DALI segments with connected ECGs and sensors and not with further DALI controllers within the segment (no multi-master mode). The power needed for ECGs and sensors is supplied directly through the gateway. An additional DALI power supply is not required, neither is it permitted.

****This applies only if the DALI-2 logo is printed on the device.*

07 B0 KNX / DALI Gateway Twin N 141/31 983D11 07 B0 KNX / DALI Gateway Twin plus N 141/21 983411 07 B0 KNX / DALI Gateway plus N 141/03 983711
--

2. Functional overview of all devices

The device can be operated with ETS 5 or higher. The described functions apply for firmware version V15. The current firmware can be accessed on the device's info display (see BMA).

If required the firmware can only be loaded to the gateway by KNX. For additional information, please see www.siemens.com/gamma-td → Additional software → Firmware download tool V6

The type and number of communication objects are determined by the number of connected DALI devices (ECGs, sensors) and functions, the configured groups and parameters.

The configuration steps are undertaken as shown conceptually in Fig. 1. Parts of the configuration can be prepared "offline", without connection to the gateway. Configuration, storage and documentation are implemented within the ETS or the parameters (plug-in). No additional files have to be backed up or archived.

Note: The sequence of steps shown represents the ideal case and can be adapted to suit the planning progress.

2.1 Modes

The gateway supports various modes, each of which is related to the device or to the group.

2.1.1 Normal mode

In normal mode, ECGs can be connected and dimmed in groups or individually without any restrictions. Three communication objects (switching, dimming and set value) also control each group or ECG (→ Section 9.2 and Section 10). A group assignment can be made only to a maximum of one DALI group. Multi-group assignments are not supported as a DALI group, but must be implemented as required by assigning KNX communication objects or by ECG control. Isolated status objects inform about the switching and value status of the groups or ECG.

2.1.2 Standalone mode

In standalone mode, the device can be operated without a connection to KNX. The configuration, which was loaded with ETS, is executed in standalone mode. (→ Section 4.4)

2.1.3 Direct mode

In direct mode, direct switching on and off and dimming are possible on the device. (→ Section 4.3)

2.1.4 Night mode (timed surface lighting)

Night mode can be enabled or disabled via an optionally selectable object (1-bit). If night mode is enabled for the group or ECG, then this channel can only be switched on at certain times (surface lighting). Both the switched on and the switched on period during night mode is variable via a parameter. (→ Section 4.3.2)

2.1.5 Constant light

The group or ECG is switched on permanently at the set value. No other parameters, except for the behavior if a bus voltage failure occurs, can be adjusted. However, status objects are available. (→ Section 9.2 or Section 10)

07 BO KNX / DALI Gateway Twin N 141/31 983D11
 07 BO KNX / DALI Gateway Twin plus N 141/21 983411
 07 BO KNX / DALI Gateway plus N 141/03 983711

2.1.6 Timer mode

A timer mode can be started by an ON telegram, a dim telegram (brighter/darker) or a dimming value telegram. In "Time switch 1-level", dimming is switched on after the switched on time has elapsed. If "Time switch 2-level" is set, the interim value is dimmed (i.e. the dimming value after the dimming time set after the switched on time 1 has elapsed. (→ Section 9.2)

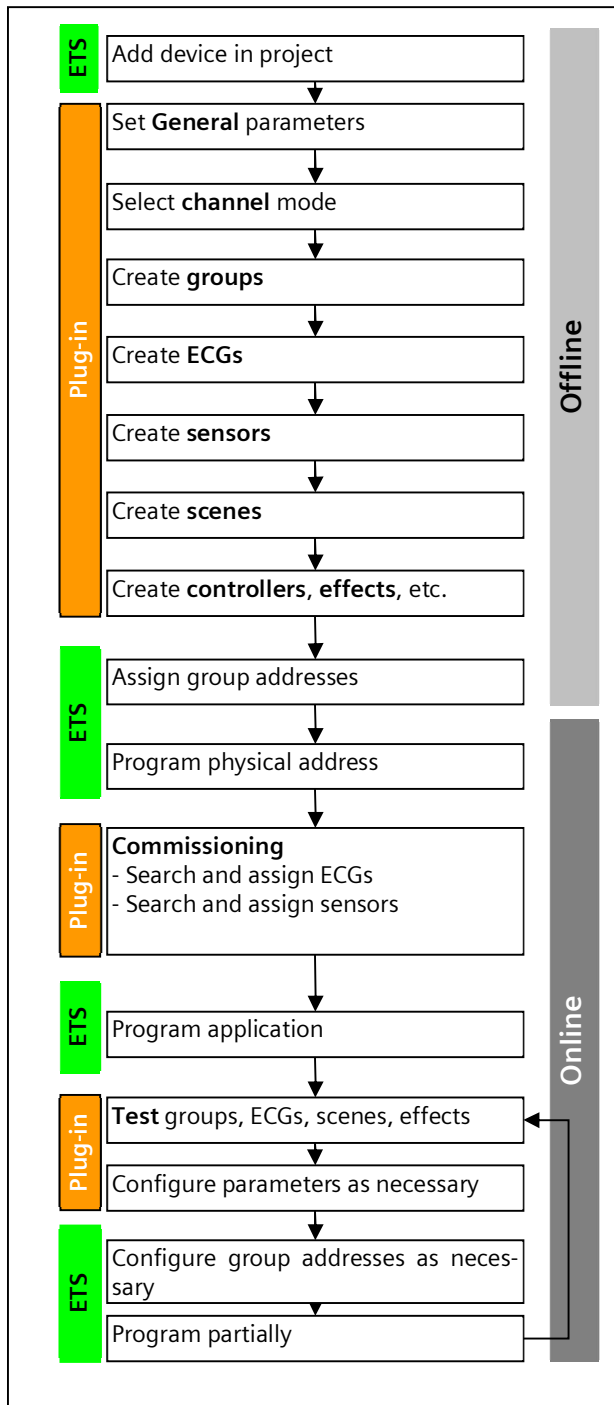

Fig. 1 Configuration steps

07 B0 KNX / DALI Gateway Twin N 141/31 983D11
 07 B0 KNX / DALI Gateway Twin plus N 141/21 983411
 07 B0 KNX / DALI Gateway plus N 141/03 983711

2.2 Replace defective DALI-ECGs

Defective one channel ECGs can be replaced without software (ETS).

Once the automatic device exchange is started, the gateway is able to test the DALI system for the completeness of the ECGs already activated.

If, for example, a defective ECG was removed by the installer and replaced by a new one, then the gateway is able to program the new ECG with the configuration data of the failed ECG. This makes it possible to replace a failed ECG by simple operation on the device and without extensive configuration work in the ETS.

The following preconditions must be noted for this:

- ECG must not have a short address (delivery condition or restored)
- ECG must not have more than one channel (short address)
- ECG has the same device type as the defective one
- Minimum physical dimming value = < set minimum dimming value
- Gateway commissioning fully completed
- Bus and mains power connected to all ECGs
- Gateway is in normal mode, direct mode or emergency mode

If more than one ECG is defective, then the individual ECGs can be replaced consecutively, whereby the correct ECG number must be selected from the system documentation for each exchange.

All other gateway functions are stopped during the device replacement process.

The Gateway tracks all of the recommended bus states during the device replacement process and evaluates the most recently tracked values (switching, dimming, brightness, scenes, effects, central function (broadcast), forced position function, locking function) at the end of the automatic device replacement process. An active forced position or locking function is interrupted by the device replacement and reactivated at the end of the replacement process if the functions have not meanwhile been deactivated by the bus.

The behavior normally occurring at the start of the forced position or locking function is not repeated in this process.







Care must be given to ensure that only one ECG is replaced in the described manner. If multiple ECGs have failed (possibly no mains voltage connected) and been replaced, the ECGs cannot be clearly identified and automatically configured by the gateway. This case requires a new start-up by the ETS plug-in. (→ Operating and display elements, see Fig. 2, page 20)







Button	Display	Description
		Replace defective one channel ECG with a new ECG (delivery state).
A6 ☰		Switch to menu with A6
A7 ▲▼	○ 5E ○	After multiple pressing of A7 menu item "ECG replacement"
A6 (briefly) ↵	● 36 ○	Pressing A6 causes the first ECG recognized as defective to be displayed with its configured ECG number (see system documentation, not short address).
A7 ▲▼	● 48 ○	Pressing A7 causes the next/previous defective ECG to be displayed.
A6 (long) ↵	● 48 ○ (blinking)	The ECG replacement process starts after A6 is pressed and held down.

07 B0 KNX / DALI Gateway Twin N 141/31 983D11
 07 B0 KNX / DALI Gateway Twin plus N 141/21 983411
 07 B0 KNX / DALI Gateway plus N 141/03 983711

Button	Display	Description
	● E0	Result: E0 = no failure E1 = short address already assigned E2 = device type not replaceable E3 = device type incorrect E4 = new ECG not found E5 = too many ECGs found E6 = unknown failures have occurred
A3 ↵		"Back" A3 is pressed to return to the menu; the menu is exited by pressing A3 again.

2.3 Failure messages on info display

Information can be accessed by pressing A6 "Menu"  (→ Fig. 2, Page 21). The selection is made by A7 . Pressing A6  "OK" takes you further, pressing A3  takes your "back". After around 5 minutes, the display returns automatically to the status display. The A7 buttons  in the first menu level and A8  in the second menu level can be used to browse forward or backward through the information.

Button	Display	Comment
	○ .	In this view, the application is unloaded. → The application has to be loaded with ETS or the device is reset to the factory settings. (Press the programming button > 20s)
A6 	○ F	Failure display menu
A6 	● 01	First failure device, channel or DALI subscriber (e.g. device)
A8 	● F7	With A8 to the next/prior failure detail in the case of channel failures: E7 = threshold of the available memory for test results reached
A7 	○ 88	Channel or DALI subscriber (e.g. Channel A)
A8 	○ F5	with A8 to the next/prior failure detail in the case of channel failures: F4 = DALI device failure F5 = DALI short circuit F6 = no ECG found
A7 	○ 36	with A7 to the next/previous failure, e.g. channel A, DALI subscriber 36
A8 	○ F0	with A8 to the next/previous ECG failure F0 = lamp defective F1 = ECG defective F2 = emergency light converter defective
	○ --	If all of the failures were corrected during the failure display, then "All failures corrected" appears in the failure code when you switch forward or back.
A3 ↵		You exit the display and return to the menu by pressing "back".

07 BO KNX / DALI Gateway Twin N 141/31 983D11
 07 BO KNX / DALI Gateway Twin plus N 141/21 983411
 07 BO KNX / DALI Gateway plus N 141/03 983711

2.4 Objects for device and channels

The following messages are available as communication objects for each channel.

2.4.1 Power failure

The 1-bit status object "Power failure" reports the status of the common power supply for the gateway and the DALI line. If the object value = "0", then the power supply is present. If the object value = "1", then the power supply has failed. With this, the gateway is no longer functional and all ECGs go to the configured dimming condition for a failure of the DALI voltage.

A short-term buffer power supply for the gateway electronics integrated with the device ensures that a mains power failure is detected and the power supply status telegram can still be transferred. These status objects are sent only if KNX communication is available (→ Section 18.2).

2.4.2 DALI device failure

The 1-bit object "[Channel], DALI device failure" reports that the power supply to DALI devices must have failed.

If more than the number configured with the parameter "Channel [A|B], failure >= DALI device(s)" are no longer responding to queries, a failure of the power supply for the DALI devices is assumed. If the object value = "0", then the power supply is present. If the object value = "1", then the power supply for the DALI devices has failed (→ Section 0).

2.4.3 DALI short circuit

The object "[Channel], DALI short circuit" reports a short circuit of the DALI channel (line). If the object value = "0", then there is no short circuit. If the object value = "1", then the DALI line has short-circuited. The DALI gateway can no longer control the DALI devices and all ECGs go to the dimming condition configured for a DALI voltage failure (→ Section 18.4).

2.4.4 Failure status (2-Byte)

The 2-byte status object "[Channel], status failure" can poll the failure status of a group at any time.

Depending on the configuration, failure messages are sent for each ECG or only after polling have ended.

2.4.5 Status switching, ECG no. xy (1-Byte)

The switching status (On/Off) of an individual DALI ECG can be both reported and queried via the 8-bit "[Channel], status switching, ECG no. xy" object. In this process bit 0 to bit 5 contain the number of the DALI ECG. Via bit 6 = 1 it is reported that the ECG/the lamp is switched on. Bit 7 is reserved for future applications.

A change in the switching status will be automatically transmitted via this object only once it has been triggered via a switching command or, respectively, via turning On/Off by dimming brighter/darker or, respectively, via an 8-bit dimming telegram and if automatic sending is enabled. No telegrams are dispatched via this status object in the event of switching status changes in the group.

If a send request is sent to this object, this request must contain the number of the DALI ECG in bit 0 to 5 and bit 6 and 7 must be set to "1". The switching status will always be transmitted upon a send request, irrespective of where it came from.

2.4.6 Status dimming value, ECG no. xy (2-Byte)

The dimming status (0...100%) of an individual DALI ECG can be both reported and queried via the 16-bit "[Channel], status dimming value, ECG no. xy" object. In this process bit 8 to bit 13 contain the number of the DALI ECG. Via bit 14 = 1 it is displayed that the ECG / the lamp is switched on. Bit 15 is reserved for future applications. Bit 0 to bit 7 contain the current dimming status as an 8-bit value (0...100%).

A change in the dimming status will be automatically transmitted via this object only once it has been triggered via a switching command or, respectively, via a dimming value telegram and the automatic sending is released. No telegrams are dispatched via this status object in the event of brightness changes in the group.

If a send request is sent to this object, this request must contain the number of the DALI ECG in bit 8 to 13 and bit 14 and 15 must be set to "1". The dimming status will always be transmitted upon a send request, irrespective of where it came from.

07 BO KNX / DALI Gateway Twin N 141/31 983D11
 07 BO KNX / DALI Gateway Twin plus N 141/21 983411
 07 BO KNX / DALI Gateway plus N 141/03 983711

2.4.7 Status failure, ECG no. xy (1-Byte)

The failure status of an individual DALI ECG can be both reported and queried via the 8-bit "[Channel], Status failure, ECG no. xy" object. In this process bit 0 to bit 5 contain the number of the DALI ECG. A lamp failure is reported via bit 6 = 1 and an ECG failure via bit 7 = 1.

If a send request is sent to this object, this request must contain the number of the DALI ECG in bit 0 to 5 and bit 6 and 7 must be set to "1".

2.5 Objects for groups

When controlling ECGs via groups, these objects are relevant for groups. (→ Section 0)

2.5.1 Switching on/off (1-bit)

ECGs connected to the gateway can be assigned to up to 32 groups.

A switching telegram to a group determines the configuration - whether the configured dimming value or the value before switching off is set. Whether the newly set value is dimmed or skipped is variable by means of a parameter. Switch-off telegrams always switch off. In timer mode, the delay time is (re)started if it has not been switched off. According to the configuration, switching telegrams enable delay times.

2.5.2 Dimming brighter/darker (4-bit)

The "Dimming time" property is variable. After receiving the start command, the gateway begins communication with the ECG to change the dimming value in the given direction with the configured speed. If a stop command is received before the dimming process has ended, the dimming process is interrupted and the dimming value reached is held. In timer mode, the delay time is (re)started if it has not been switched off. A parameter determines whether you can switch on and off via dimming.

2.5.3 Dimming value 8-bit value (1 byte)

The communication object with the description "[Channel], [Group], Dimming value", sets all ECGs in this group to the transferred dimming value. Whether this value is skipped or dimmed is configurable. Depending on the configuration, say this object receives the value 0, the corresponding group is switched off. Values less than the minimum value (with the exception of the value 0) and values greater than the maximum value are limited to the minimum and maximum dimming values respectively. A parameter determines whether a switched off ECG assumes the received value immediately and switches on or assumes the received value only with an ON command. The configured switching value is then invalid. Depending on the configuration, dimming value telegrams also enable delay times. A communication object (3 bytes) can also control the group via a dimming value with a dimming time.

2.5.4 Dimming value limits

Limiting is used to configure maximum and minimum dimming values. With all switching/dimming processes, the dimming value can only be changed within the configured limits. (→ Section **Fehler! Verweisquelle konnte nicht gefunden werden.**)

2.5.5 Dim color temperature warmer / colder (4-bit)

The "dimming time" property can be configured. After receiving the color temperature command, the gateway commences communication with the ECG to change the color temperature value in the specified direction at the configured speed. If a stop command is received before the dimming process has ended, the dimming process is interrupted and the color temperature value reached is held.

2.5.6 Color temperature value 16-bit value (2 bytes)

The communication object with the description "[Channel], [Group], color temperature value" sets all ECGs in this group to the transferred color temperature value. Whether this value is skipped or dimmed is configurable. Values less than the minimum value and values greater than the maximum value are limited to the minimum and maximum color temperature values respectively. A parameter can be used to determined to which color temperature value dimming is to take place for an ON command.

2.5.7 Color temperature limits

Limiting is used to configure maximum and minimum color temperature values. With all the color temperature dimming processes, the color temperature value can only be changed within the configured limits. Switching status (1-bit)

The on/off status of any group can be sent via a communication object "[Channel], [Group], status switching" on a read demand or automatically on an object value change.

07 B0 KNX / DALI Gateway Twin N 141/31 983D11 07 B0 KNX / DALI Gateway Twin plus N 141/21 983411 07 B0 KNX / DALI Gateway plus N 141/03 983711
--

2.5.9 Dimming value status (8-bit)

The object "[Channel], [Group], status dimming value" is an 8-bit status object. It contains the current dimming value for the relevant group. It can be sent and/or read independently.

2.5.10 Color temperature status (16-bit)

The object "[Channel], [Group], color temperature value status" is a 16-bit status object. It contains the current color temperature value for the relevant group. It can be sent and/or read independently.

2.5.11 Failure status (1-bit)

The 1-bit object "[Channel], [Group], status failure" can, for each group, report a detected lighting failure or ECG or converter failure for a subscriber in this group, or also poll the status at any time.

2.5.12 Failure status (4-Byte)

This 4-byte status object "[Channel], [Group], status failure (4-byte)" transmits the quantity of ECG and inverters assigned to this group and the quantity and type of failures that have been detected in this group.

This object will be transmitted as set by the parameter "Group, status failure (4-Byte)".

2.6 Scene control (8-bit)

The application program can configure up to 16 scenes per channel, each of which can contain up to 16 groups per channel. Scenes are saved and called up via the 8-bit object "8-bit scene, Recall/Save". Timer functions cannot be executed within a scene. (→ Section 13)

07 B0 KNX / DALI Gateway Twin N 141/31 983D11
 07 B0 KNX / DALI Gateway Twin plus N 141/21 983411
 07 B0 KNX / DALI Gateway plus N 141/03 983711

3. Selectable functions

The table 1 contains an overview of the selectable functions for each KNX/DALI Gateway.

3.1 Sensors

The gateway supports selected sensors, such as key interfaces, presence detectors and brightness sensors with a DALI interface. Sensors are powered by the gateway. Sensors can be connected individually with other objects via the objects and are therefore independent. (→ Section 11)

3.2 ECG

ECGs can be controlled individually without group assignment. The functions are to be seen as being similar to the group control functions described in Section 2.4.4.

3.3 2-point lighting control

Up to sixteen independent switching brightness controllers (2-point controllers) are provided. These are independent of all other functions and can be used via objects. (→ Section 14)

3.4 Constant lighting control

Up to sixteen independent constantly operating lighting controllers are provided. These are independent of all other functions and can be connected and used both internally and externally via objects. (→ Section 15.3)

3.5 Stand-by

This function makes it possible to define up to 6 areas per channel, for which the ECG power supply is shut off by a separate load switch when all of the ECGs in this area have a brightness value of zero (0). This serves to reduce the quiescent power consumption of the ECGs. (→ Section 12)

3.6 Timer







This function makes it possible to define up to ten channels which can be assigned to up to 2000 switching times. The switching times can be defined as daily/weekly or date schedules and as absolute time or relative to the sunrise/sunset. (→ Section 16.6)

3.7 Effect control (Sequencer)

A maximum of 1000 steps can be assigned to up to 20 effect channels in up to four effects. These effect channels can be assigned to various object types. These objects can be used both internally and externally by means of object assignments via group addresses. The effects can run in parallel and use an object to display the current status. (→ Section 14)

3.8 Burn-in function (Complete system)

The burn-in function for the complete system makes it possible to have all of the ECGs switched on to 100% following a defined time period (Standard = 100 hrs) after the initial start-up of the system. The control buttons on the device can be used to start the burn-in operation (see below and Fig. 2 Gateway control and display elements – Page 20).

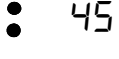
Button	Display	Description
A6 		Switch to menu with A6
A7 		After multiple pressing of A7 "Burn-in - BU"
A6 (long) 		"Burn-in" is started when A6 is pressed and held down.
A6 (briefly) 		The "Burn-in" time remaining is displayed in hours when A6 is briefly pressed e. g. 45 hours. HI is displayed at > 99 hours

07 B0 KNX / DALI Gateway Twin N 141/31 983D11
 07 B0 KNX / DALI Gateway Twin plus N 141/21 983411
 07 B0 KNX / DALI Gateway plus N 141/03 983711

Button	Display	Description
A3 (long) ↵		Burn-in remains active until the time has completely elapsed. The process can be ended by pressing and holding down A3.

The parameter set by the ECGs or the standard value applies. Upon completion of the burn-in operation, the device switches automatically to normal mode (bus mode) or to stand-alone mode depending on the configuration. All of the ECGs are shut off.

General	
System	
Parameters	Settings
Burn-in process duration [h]	1...200 100
This parameter is used to enter the burn-in time.	

The time remaining is saved if a power loss occurs during the burn-in operation. The burn-in operation continues for the time remaining after the power is restored.

3.9 Burn-in function via object

The burn-in can be controlled by one of the following objects:

Object name	Function	Type	Flag																																				
[Channel], Burn-in	receive	1 byte	CW																																				
The burn-in of an ECG is started or ended by this object. The following bit assignment is also used:																																							
Bit 7	6	5 - 0																																					
Command	Address indicator	Address																																					
<p>"Command" To be set to 0 for starting the burn-in process and to 1 for ending the burn-in process. "Address indicator" 0 = ECG, 1 = Group "Address" contains the number of the ECG as a binary number in the range 0...63, with the binary number 0 equating to ECG number 1, etc. or the group address 0...15, whereby the binary number 0 equates to group 1. The command is ignored if an ECG was addressed in a group. If the broadcast mode for the channel is activated, then it is addressed by the following value: Address indicator 1, Address: 63</p> <p>Example:</p> <p>ECG</p> <table border="1"> <tr> <td>Burn-in</td> <td>Start</td> <td>End</td> </tr> <tr> <td>1</td> <td>0</td> <td>128</td> </tr> <tr> <td>2</td> <td>1</td> <td>129</td> </tr> <tr> <td>...</td> <td></td> <td></td> </tr> <tr> <td>64</td> <td>63</td> <td>191</td> </tr> </table> <p>Group</p> <table border="1"> <tr> <td>Burn-in</td> <td>Start</td> <td>End</td> </tr> <tr> <td>1</td> <td>64</td> <td>192</td> </tr> <tr> <td>2</td> <td>65</td> <td>193</td> </tr> <tr> <td>...</td> <td></td> <td></td> </tr> <tr> <td>16</td> <td>80</td> <td>208</td> </tr> </table> <p>Broadcast</p> <table border="1"> <tr> <td>Burn-in</td> <td>Start</td> <td>End</td> </tr> <tr> <td></td> <td>127</td> <td>255</td> </tr> </table>				Burn-in	Start	End	1	0	128	2	1	129	...			64	63	191	Burn-in	Start	End	1	64	192	2	65	193	...			16	80	208	Burn-in	Start	End		127	255
Burn-in	Start	End																																					
1	0	128																																					
2	1	129																																					
...																																							
64	63	191																																					
Burn-in	Start	End																																					
1	64	192																																					
2	65	193																																					
...																																							
16	80	208																																					
Burn-in	Start	End																																					
	127	255																																					

07 BO KNX / DALI Gateway Twin N 141/31 983D11
 07 BO KNX / DALI Gateway Twin plus N 141/21 983411
 07 BO KNX / DALI Gateway plus N 141/03 983711

Object name	Function	Type	Flag
[Channel], burn-in status	send/request	2 byte	CWT
This object can be used to query whether the burn-in process is active or inactive. The following bit assignment is also used:			
Bit 15	14 - 9	8	
not used	not used	Status	
Bit 7	6	5 - 0	
Command	Address indicator	Address	
"Status" 0 Burn-in inactive, 1 Burn-in active. If 0 is entered in the command, then the status bit must be set to 0. "Command" Query 1, Response 0 "Address indicator" 0 = ECG, 1 = Group address "Address" contains the number of the ECG as a binary number in the range 0...63, with the binary number 0 equating to ECG number 1, etc. or the group address 0...15, whereby the binary number 0 equates to group 1. The command is ignored if an ECG was addressed in a group. If the broadcast mode for the line is activated, then it is addressed by the following value: Address indicator 1, Address: 63			
Example:			
ECG	Query	Status active	Status inactive
1	128	256	0
2	129	257	1
...			
64	191	319	63
Group	Query	Status active	Status inactive
1	192	320	64
2	193	321	65
...			
16	207	335	79
Query broadcast		Status active	Status inactive
	255	383	127

The function is similar to constant light. The controlled value is the maximum configured dimming value. The ECG or group can no longer be controlled by the objects. An ongoing time function is interrupted. Failures continue to be reported. The status displays the maximum dimming value.

The "behavior following burn-in" can be defined in the configuration for groups or ECGs.

After the burn-in process is deactivated, the ECG or group is set indefinitely to the value defined by the "Value at the end of the burn-in function" parameter.

Commands for scenes contained in an ECG or group are discarded during the burn-in process.

If the "Value at the end of the burn-in function" parameter is set to "No burn-in possible", then the burn-in process cannot be started for this element.

The burn-in function is deactivated and the "Value at the end of the burn-in function" parameter is set to "No burn-in possible" for an ECG with activated brightness control.

The status of the burn-in function is saved when a power loss occurs.

07 B0 KNX / DALI Gateway Twin N 141/31 983D11
 07 B0 KNX / DALI Gateway Twin plus N 141/21 983411
 07 B0 KNX / DALI Gateway plus N 141/03 983711

3.10 Emergency mode

The gateway supports both emergency lighting systems with a central battery supply and emergency lights with an individual battery supply as per IEC62386-202 with one or two DALI devices. In the case of central battery supply, the "dimming value in emergency mode" and "color temperature in emergency mode" can be set within the ECG parameter settings. These are transmitted to the ECG as the "System Failure Level" dimming value and color temperature value in the case of DALI failure on the ECG on the one hand, and on the other hand, sent to the ECG as a dimming value and color temperature value if this is activated via the emergency mode object.







3.10.1 Emergency lighting test results

It is possible to perform cyclical function tests in accordance with the legal requirements when emergency light ECGs are used with individual battery supplies. The test results can be forwarded by an object either to a documentation system or to an internal memory. The internal memory can be read out with the ETS Plug-in and backed up in a file. (→ Section 0)

The data are written over on a rolling basis when the memory overflows, with the upcoming memory overflow being reported by an object and by the screen info-display.

3.10.2 Blocking battery mode for emergency lights

Emergency lighting ECGs with batteries convert automatically to their individual battery supply when a general power failure occurs. It is necessary in special cases, e.g. during the construction phase, to switch off the power supply to the emergency lights operated by individual batteries without these lights converting to emergency mode. The gateway inserts a locking indicator in the emergency light ECG when this mode (inhibit) is activated in accordance with the following description (see Fig. 2 Gateway control and display elements – Page 20):

Button	Display	Description
A6 		Switch to menu with A6
A7 	○  ○	After multiple pressing of the A7 menu item "□"
A6 (long) 	○  ○ (blinks)	Pressing and holding down A6 sets the lock.
A3 		"Back" A3 is pressed to return to the menu; the menu is exited by pressing A3 again.

The setting of the locking indicator is signaled by a brief flashing of the emergency lighting LED. If the power is shut off, e.g. by tripping the miniature circuit breaker, within 15 minutes after setting the locking indicator, then this does not go into emergency mode and thus remains disabled until the power is restored. After the power is restored, the emergency light ECG goes into standard mode and the locking indicator is deleted.

3.10.3 Disable failure status messages

ECGs are disconnected from DALI in connection with the emergency lighting test. The gateway evaluates this disconnection as an ECG failure and thus also sends failure telegrams via KNX. The sending of failure messages can be disabled to prevent this unnecessary information. → Section 9.7

07 B0 KNX / DALI Gateway Twin N 141/31 983D11
 07 B0 KNX / DALI Gateway Twin plus N 141/21 983411
 07 B0 KNX / DALI Gateway plus N 141/03 983711

3.10.4 Emergency mode configuration

The "Emergency mode" object can be used to dim all lights not controlled by a DALI gateway to the configured "dimming value in emergency mode" and "color temperature in emergency mode" in order to dim all of the lights to the same brightness/color temperature value as the battery-operated emergency lights when a mains failure or communication failure occurs via the DALI cable.

The following actions are taken at the start of emergency mode:

- The dimming values and color temperature values for emergency mode are set.
- An actively running effect is stopped.
- The constant lighting controls are stopped.
- All of the time functions are stopped.
- The execution of timer commands is interrupted.

The following restrictions result during emergency mode:

- None of the lights react to switching and dimming commands while "emergency mode" is activated.
- No effects can be started or scenes called up.
- The constant lighting control cannot be started.
- The execution of timer actions is stopped.
- No commissioning can be carried out.

The following actions are taken under this priority at the end of the emergency mode.

- Commands for switching, dimming values, color temperature values, and scenes are updated, but not relative dimming.
- The dimming values and color temperature values are set according to the parameter setting if no other values were received.
- Restart of the time functions, if the ECG / Group is on.
- Constant light control remains off.
- Time functions are updated in accordance with the parameter setting.

Object name	Function	Type	Flag
Emergency mode	on/off	1 bit 1.001	CW
If the DALI gateway receives the logical value "1" (1= emergency mode ON), via the "Emergency mode" object linked to this group address, then all of the connected lights dim to the value defined by the "dimming value for emergency mode" and "color temperature for emergency mode" parameters. If the logical value "0" is received by the object, then the time specified by the "Gateway delay time following emergency mode OFF" begins to run. Once this time has expired, the gateway dims all of the connected lights to the dimming and color temperature values defined by the "Behavior during Emergency mode OFF" parameter.			

The behavior can be influenced by the following parameters:

General	
Emergency mode	
Parameters	Settings
Delay after emergency mode OFF [mm:ss]	00:00 – 20:00 00:00
This parameter is used to define the time period, after which the lights with activated emergency mode should be switched or dimmed to the value defined by the "Behavior during Emergency mode OFF" parameter after the "Emergency mode" object has been reset to logical "0".	

07 B0 KNX / DALI Gateway Twin N 141/31 983D11 07 B0 KNX / DALI Gateway Twin plus N 141/21 983411 07 B0 KNX / DALI Gateway plus N 141/03 983711
--

3.11 Standard applications

The gateway supports a series of standard applications for pure DALI operation without KNX. These can be activated without software (ETS) by using the control buttons. These standard applications exclusively use broadcast to control the DALI channels and incorporate DALI-enabled sensors into the application. (→ Section 25)

07 B0 KNX / DALI Gateway Twin N 141/31 983D11 07 B0 KNX / DALI Gateway Twin plus N 141/21 983411 07 B0 KNX / DALI Gateway plus N 141/03 983711
--

4. Modes

The device can be operated in different modes. There is a distinction between device and channel modes.

4.1 Normal mode (bus mode)

In normal mode, ECGs can be connected and dimmed in groups or individually without any restrictions. In this process three communication objects (switching, dimming and set value) control each group or ECG.

A group assignment can be made only to a maximum of one DALI group. Multi-group assignments are not supported as a DALI group, but must be implemented as required by assigning KNX communication objects.

Isolated status objects provide information about the switching and value status of the groups.

4.2 Central commands (Broadcast)

The DALI channel Broadcast mode controls all connected ECGs simultaneously via the Broadcast commands provided by DALI. Sensors are not included. (→ 0)

4.3 Direct mode

In direct mode, direct on/off switching and dimming are possible on the device. For this, the device has a key (A3) on the front to disable or enable "Direct Mode". If the key is held down, then the display (A13) indicates direct mode by "d". This switches on (tap key) or dims (key held down) together all ECGs controlled via the relevant channel, by means of the key pair (A7 and A8).

The LED (A4) indicates the switching status of the connected lights (flashing during undefined status). If the "Direct mode" key is held down again, the device reverts to normal mode or to standalone mode, if KNX is not available. In factory default settings, the duration of the direct operation infinite (endless). The duration can be edited by an ETS download.

In the delivery state, the duration of the direct operation is unlimited if any failure is signaled in the display by a flashing *F*.

In direct mode, switching, dimming value or scene call-up commands received via bus or DALI sensors are not forwarded to the connected ECGs but are saved as desired target conditions or sent via the corresponding communication object. After reverting to normal mode, the dimming values that were valid before direct mode are restored, taking into account the target condition saved during direct mode. The function of the DALI sensors relative to the bus communication remains unaffected during direct mode. The dimming values valid for normal mode (before the change to direct mode + tracking control) are restored after quitting direct mode. Saved status values are sent during direct mode, but there is no check of actual ECG dimming values.

Scene commands with a save function, which were received during direct mode, are discarded. Scene call-ups without a save function are executed after quitting direct mode.

Direct mode is switched off after a mains power failure. The device enters normal mode or standalone mode when the mains power is restored. Dimming values are tracked automatically, as is also stipulated when switching back to the relevant mode.

07 B0 KNX / DALI Gateway Twin N 141/31 983D11
 07 B0 KNX / DALI Gateway Twin plus N 141/21 983411
 07 B0 KNX / DALI Gateway plus N 141/03 983711

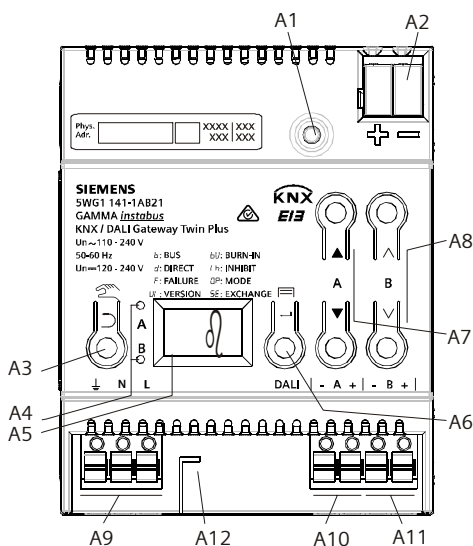

Fig. 2 Gateway control and display elements

- A1 Programming button with LED (red)
Programming mode: Briefly pressing and releasing the programming button (< 0.5 s) activates the programming mode. This is displayed by flashing of the programming LED.
Factory settings: Pressing and holding down the programming button for a prolonged time period (> 20 s) restores the device to its factory settings. This is displayed by uniform flashing of the programming LED. The flashing stops after 5 s.
Note: No functions are executed when the programming button is held down for a longer period of time (> 0.5 s to 2 s). The device can be blocked for programming mode for approx. 10 s. This is displayed by brief flashing of the programming LED.
- A2 KNX terminal
- A3 Button when pressed briefly: "back" ↶ held down: Direct mode ↷
- A4 These two LEDs are used to display information about the respective channel.
- A5 Device information display
- A6 Button when pressed "OK" ← or Menu ≡
- A7 Button pair ▲ ▼ for menu control or direct operation of channel A
- A8 Button pair ^ v submenu control or direction operation of channel B (not for N 141/03)
- A9 Terminals for earthing, neutral and phase conductors (L, N, earth)
- A10 Terminal pair for DALI channel A
- A10 Terminal pair for DALI channel B
- A12 Stripping template (stamping)

07 B0 KNX / DALI Gateway Twin N 141/31 983D11
 07 B0 KNX / DALI Gateway Twin plus N 141/21 983411
 07 B0 KNX / DALI Gateway plus N 141/03 983711

4.3.1 Parameters

General	
System	
Parameters	Settings
ON period during direct mode [minutes, 0 = unlimited]	0...60 15
This parameter is used to set the time elapsing before normal mode is automatically restored. 0 minutes corresponds to an unlimited direct mode in delivery condition.	

4.3.2 Object

No.	Object name	Function	Type	Flag
2	Direct mode status	on/off	1 bit 1.011	CRT
This object reports that the gateway was switched from normal mode to direct mode (direct mode = on) or was switched back from direct mode to normal mode (direct mode = off).				

4.4 Standalone mode

In standalone mode, the device can be operated without a connection to KNX. The configuration, which was loaded with ETS, is executed in standalone mode. Standalone mode must be approved via the following parameters:

General	
Behavior during ramp-up and failure	
Parameters	Settings
In the case of bus power failure, switch to standalone mode.	Yes No
If this parameter is set to "no", then the gateway behaves as usual. If the parameter is set to "yes", no special actions take place on a bus voltage failure/recovery. The behavior during a bus voltage failure is described in section 23.	

07 B0 KNX / DALI Gateway Twin N 141/31 983D11
 07 B0 KNX / DALI Gateway Twin plus N 141/21 983411
 07 B0 KNX / DALI Gateway plus N 141/03 983711

4.5 Night mode

The Night mode is a mode in which all groups or ECG that is configured for night operation is controlled with the same functionality. The night mode is analogous to a stairwell operation. The switch-on value can be set for night operation. (Switch-on (night) → 9.2)

4.5.1 Parameters

If the group is to be operated in "Normal/Night mode" and if the "Warn before switching off" setting is to be enabled, it must be configured in the group settings. (→ 9.2)

If "Warn before switching off" is enabled, then the relevant channel will be reduced to half the former switching value (lamp output) at the end of the switch-on time, to indicate in this way to the room user that the lighting will soon be switched off. Pressing the On switch again dims the lighting immediately to the switch-on value and the timer is restarted.

General	
Night mode	
Parameters	Settings
Night mode	No Yes
This parameter enables Night mode with yes and fades in the parameters below.	
On-time night mode [minutes]	5..60 5
This parameter sets how long the channel is to remain switched on in night mode. If a switching, dimming, dimming value or scene call-up command is received before this time has elapsed, then the on time is restarted, i.e. it is extended by the set time.	
When luminaires are switched on, limit the switch-on time when switching to night mode	No Yes
The behavior of the already switched-on lights when switching to night mode can be set: No = If groups and ECG that are configured for night mode are switched on when night mode is enabled, these remain switched on. Yes = If groups that are configured for night mode are switched on when night mode is enabled, these switch off after the time has elapsed.	
When luminaires are switched on, cancel the limitation of the switch-on time when switching to day mode	No Yes
The behavior of the already switched-on lights when switching to normal mode can be set: No = If groups and ECG that are configured for night mode are switched on when night mode is disabled, these switch off after the time has elapsed. If they are only switched on after this, they remain on constantly. Yes = If groups that are configured for night mode are switched on when night mode is disabled, these remain switched on.	

4.5.2 Object

This object is visible only if the parameter "Night mode" is set to "Yes".

No.	Object name	Function	Type	Flag
1	Night mode	on/off	1 bit 1.003	CWTU
This object enables or disables "Night mode" via the bus. The object can also be sent by a button, a timer or an automatic building management system, for example. If a logical 1 is received, then the channel switches to night mode.				

07 B0 KNX / DALI Gateway Twin N 141/31 983D11
 07 B0 KNX / DALI Gateway Twin plus N 141/21 983411
 07 B0 KNX / DALI Gateway plus N 141/03 983711

5. ETS application program

The application for the KNX/DALI gateway is designed as a plug-in for the ETS (from version 5 or higher). All necessary program files are created automatically when the corresponding ETS product database (vd5/knxprod) is imported. The product can be added as usual to the ETS after import. When the product is called up for the first time in the ETS, the installation of the necessary plug-in files is started. The installation routine instructions must be followed.

Note:

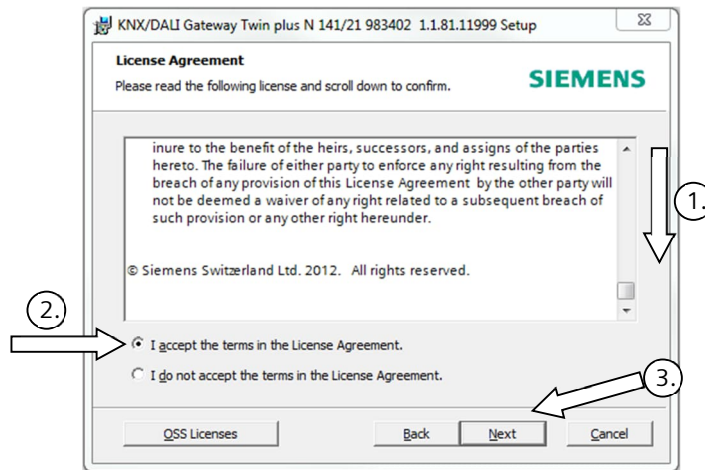

Fig. 3 Licensing conditions dialog box

You must accept the license conditions before installation. This is only possible if you have scrolled down the complete license conditions ① to the end. Only then will the "I accept ..." option ② be further enabled for confirmation by ③.

5.1 Parameter windows

The plug-in is opened when the parameters are called up.

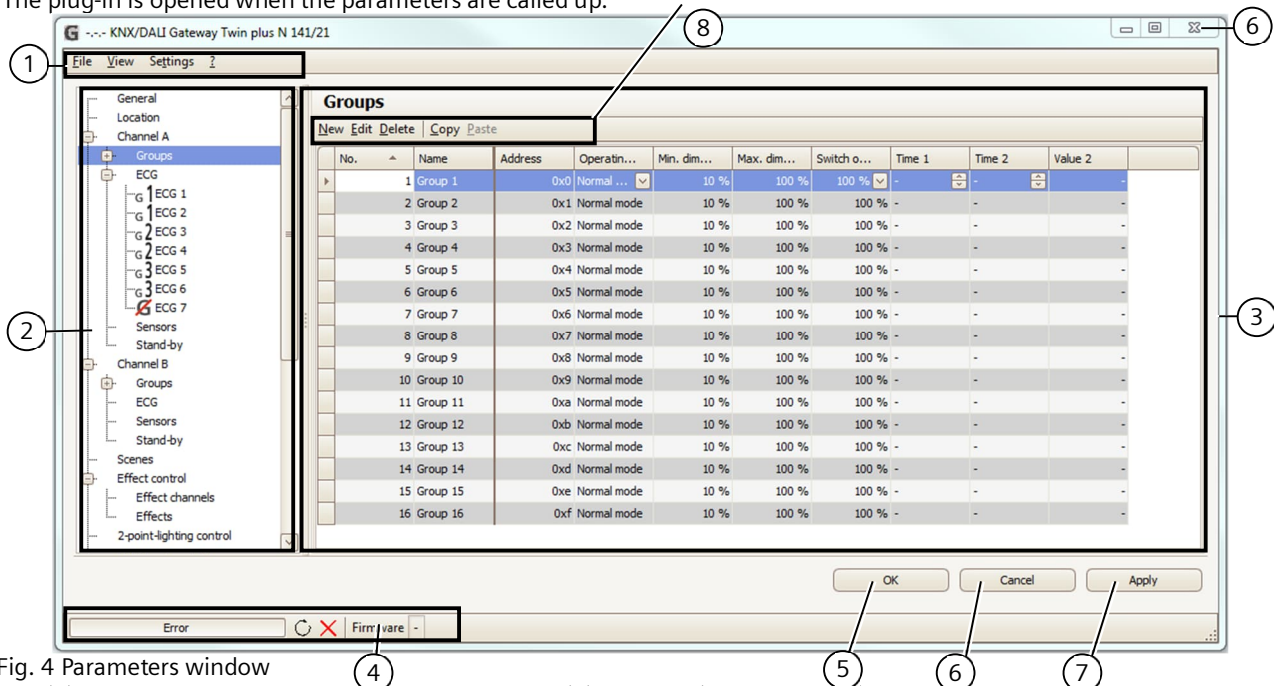

Fig. 4 Parameters window

- (1) Menu bar → see 5.2
- (2) Overview → see 0
- (3) Parameters window → see 5.4
- (4) Status line → see 21.1.2
- (5) OK (Save and close)
- (6) Cancel (Close without saving)
- (7) Accept (Save)
- (8) Parameters window menu

07 B0 KNX / DALI Gateway Twin N 141/31 983D11
 07 B0 KNX / DALI Gateway Twin plus N 141/21 983411
 07 B0 KNX / DALI Gateway plus N 141/03 983711

5.2 Menu bar

File	
Save	Saves the current settings, corresponds to the "Accept" key. This saves all changes inside the ETS. Saving within the gateway is effected only by programming (download) in the gateway. In this way, setting can be prepared without connecting to the gateway.
Import Export	The complete configuration of the device can be exported and imported via a XML file. On import, XML configuration files from other Siemens gateways are converted automatically (see Section 19).
Print preview	Generate the document as preview. (→ Section 20)
Printing	Prints the equipment documentation (→ Section 21)
End	End the plug-in. Before closing the plug-in, you are prompted to save the changes, if relevant.
View	
Reset all views	All user settings relating to column width, sorting, etc. are reset in all work areas.
Reset current view	All user settings relating to column width, sorting, etc. are reset in the current work area.
Settings	
Restore all settings	All settings are restored to the default values. All settings will be deleted. Note: Saving in the ETS can be aborted with "Cancel".
Restore current settings	Only the settings for the current work area are restored.
Options	
General	Adapt column width automatically: When you open a parameter list are all column widths automatically adjusted. Show download options at closing: When you close the plugin there is a note, for example, if the scenes by the download will be overwritten. Warn on removing of group associations: When you close the plugin there is a note that possibly already linked group addresses are deleted.
Commissioning	Adapt device type automatically: When you assign the found ECG, it is checked to determine whether the configured DALI device type matches with the found device type. If this is not the case, it will be changed automatically to the found device type . Select next ECG at assignment automatically: This option facilitates the fast assignment of ECG in the menu "Commissioning". Replace random addresses after searching automatically: The plugin automatically replaces the existing random number (RND) by a newly found random number (RND), if all other conditions (Device Type, ...) match. Additionally, at next download a new download to ECG are enforced. Do not use already assigned short addresses: Are ECG already assigned and configured, used DALI short addresses will not be used again. This is important, if new ECG being sought and the pre-configured ECG is not supplied with mains voltage. E.g. the lights (ECG) of two rooms are pre-configured and in operation. Now, another room with lights (ECG) in addition be taken into operation. In the search for time to save money and only assign lights in a new room, the lights of the two finished rooms separated from the mains voltage. In the search only the ECG of the new space is found, there will be new DALI short addresses assigned. This means that no previously used DALI short addresses assigned again.

07 B0 KNX / DALI Gateway Twin N 141/31 983D11
 07 B0 KNX / DALI Gateway Twin plus N 141/21 983411
 07 B0 KNX / DALI Gateway plus N 141/03 983711

Commissioning with blinking	Time for minimum/maximum value: These parameters serve to adjust the flashing duration during commissioning. Depending on the type of the illuminated different values are to be applied.
? (Help)	
License	You can view the license agreement here
OSS license	You can view free licenses used here
Info	Version information

Note: If the communication object is shown in the wrong language, simply open the plug-in and close it again with OK after changing the system language.

07 B0 KNX / DALI Gateway Twin N 141/31 983D11
 07 B0 KNX / DALI Gateway Twin plus N 141/21 983411
 07 B0 KNX / DALI Gateway plus N 141/03 983711

5.3 Overview

The overview shows the different parameter pages as nodes in a tree structure, which is tailored to the commissioning steps in the sequence from top to bottom. A parameter page for configuring settings is assigned to each node. Some assignments (e.g. assign an ECG to a group) can be made within the overview using drag and drop. A context menu that can be called up by right-clicking on the mouse is offered to nodes within the overview.

5.4 Parameter windows

The parameters page is shown differently, adapted to the parameter requirements: table, parameters page, etc. A tabular representation in the parameters page can be customized via a context menu by right-clicking on the column heading. The settings are kept until the view is reset via the menu bar.

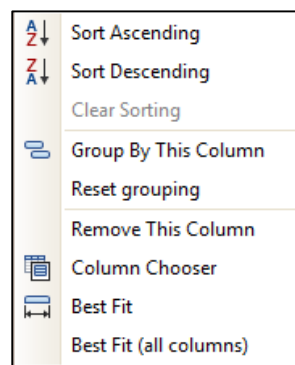

Fig. 5 Columns context menu

5.5 Transferring parameters

Parameters can be transferred to other lines in the tabular representation of groups, ECGs and sensors.

Procedure:

- Mark the relevant lines (Left-click together with CTRL for single lines or the first and last with SHIFT)
- Hold down the CTRL key and right-click on the line with the settings to be transferred
- Left-click on "Transfer parameters"
- All marked lines have identical settings

07 B0 KNX / DALI Gateway Twin N 141/31 983D11
07 B0 KNX / DALI Gateway Twin plus N 141/21 983411
07 B0 KNX / DALI Gateway plus N 141/03 983711

6. Communication objects

Maximum number of group addresses: 4095

Maximum number of assignments: 4095

The gateway has a large number of communication objects, which are broken down into the following blocks:

from	to	Description
1		Night mode
2		Direct mode status
3	4	Scene
5	29	Effects controller
30	34	Status failure
35		Block failure status messages
36		Emergency mode
37		A, status failure
38	168	A, groups
169	680	A, ECG
688	689	A, Burn-in
690	817	A, ECG, test or test result
818		A, test result expanded
819		B, status failure
820	950	B, groups
951	1462	B, ECG
1470	1471	B, Burn-in
1472	1599	B, ECG, test or test result
1600		B, test result expanded
1601	1602	Memory test results
1603	1614	Stand-by
1632	2270	A, sensors
2288	2926	B, sensors
2927	3102	2-point lighting control
3103	3470	Constant lighting control
3471	3472	Time and date
3473	3492	Timer channels

07 B0 KNX / DALI Gateway Twin N 141/31 983D11
 07 B0 KNX / DALI Gateway Twin plus N 141/21 983411
 07 B0 KNX / DALI Gateway plus N 141/03 983711

7. Status

In the overview "Status" a summary of the configuration is displayed. The values are only by pressing the "Read" status values read from the device. By pressing the button "Update (60s)", the values are read out automatically every 60 seconds. By pressing the automatic reading is disabled.

7.1 View Status

This view shows a summary of the device configuration.

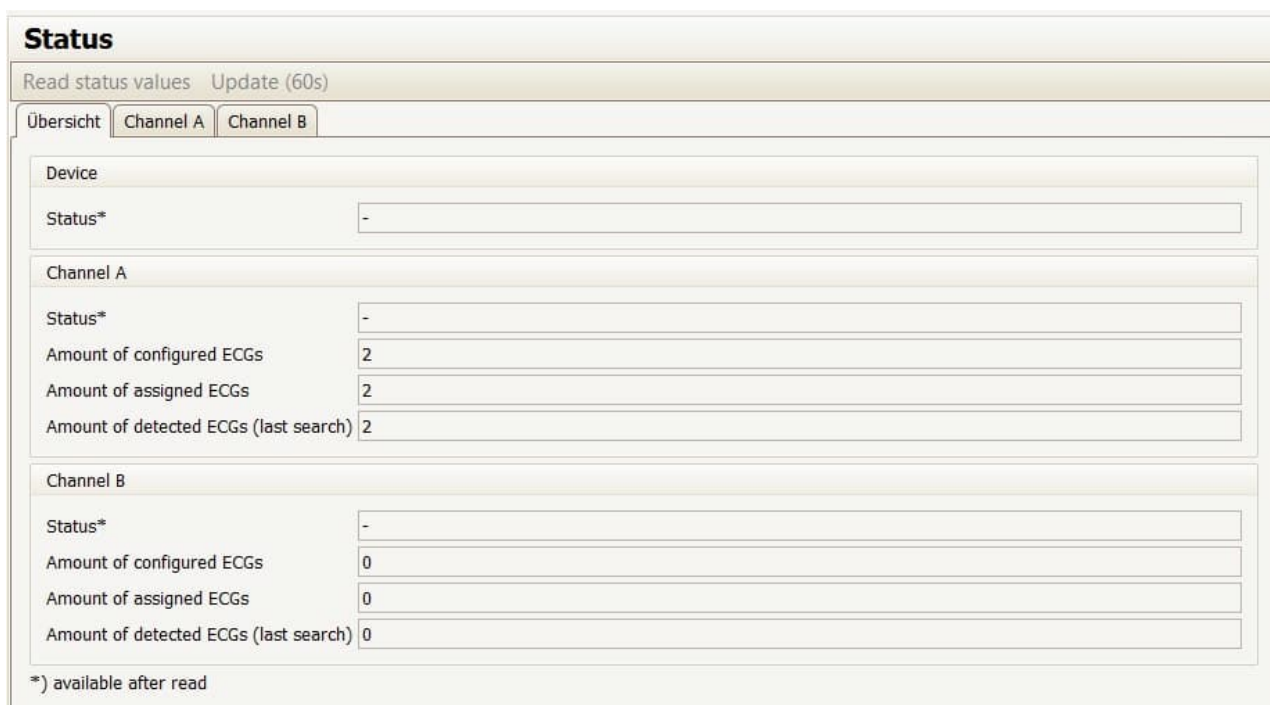

Fig. 6 Parameter Status – Overview

Status	
Device	
Parameter	Settings
Status	<p>The current operating status of the device is displayed:</p> <p><u>OK:</u> The device is in normal mode.</p> <p><u>Direct mode:</u> The device is in direct mode.</p> <p><u>Emergency mode:</u> The device is in emergency mode.</p> <p>Threshold of free memory locations for test results exceeded: The device is in normal mode, but the threshold of the free storage of test results has reached the warning limit. Check if the saved data should be stored external.</p>

07 B0 KNX / DALI Gateway Twin N 141/31 983D11
 07 B0 KNX / DALI Gateway Twin plus N 141/21 983411
 07 B0 KNX / DALI Gateway plus N 141/03 983711

Status	
Channel A (B)	
Parameter	Settings
Status	<p>The current status of the channel is displayed:</p> <p>OK: The channel is in normal mode without disturbances or failures.</p> <p>DALI device failure: At a channel a DALI device failure was detected.</p> <p>DALI short circuit: At a channel a short circuit of the DALI installation was detected.</p> <p>External voltage: A incorrect voltage (> 24 V) was detected at DALI channels. Check the installation</p> <p>No ECG found: There were no ECG detected on the DALI channel.</p> <p>Start: The channel is in the initialization phase.</p>
Amount of configured ECGs	Amount of configured ECGs within the PlugIn.
Amount of assigned ECGs	Amount of assigned ECGs within the PlugIn.
Amount of detected ECGs (last search)	Amount of detected ECGs at the last ECG search.

Marked *) values are only available, if the values were red from the device.

07 B0 KNX / DALI Gateway Twin N 141/31 983D11
 07 B0 KNX / DALI Gateway Twin plus N 141/21 983411
 07 B0 KNX / DALI Gateway plus N 141/03 983711

7.2 View Status – Channel A (B)

This view shows all configured ECG on the respective channel. Only by pressing "Read" the current values are status values were red from the ECGs.

Note: The current dimming value status corresponds with the KNX status. A internal status occurred by "Test ECG or Group" will not be considered.

Status							
Read status values		Update (60s)					
Übersicht		Channel A		Channel B			
ECG 1 Group 1 0 %	ECG 2 Group 1 0 %	ECG 3 (none) 0 %	ECG 4 (none) X	ECG 5 (none) X	ECG 6 (none) X	ECG 7 (none) X	ECG 8 (none) X
ECG 9 (none) X	ECG 10 (none) X	ECG 11 (none) 0 %	ECG 12 (none) 0 %	ECG 13 (none) X	ECG 14 (none) X	ECG 15 (none) X	

Fig. 7 View Status - Channel

View	Settings
<p>ECG 4</p> <p>Group: (none) Device type: 0 - Fluorescent lamps Short address: - Dimming value status: X Status standby: - Error: Lamp failure</p> <p>Legend: Black - yellow: Status available (%) Light grey: No status available (-) Grey: No short address assigned (X) Dark grey: Not configured Red: Error</p> <p>Fig. 8 View Status - Channel – Mouse over</p>	<p>If you position the mouse pointer over a field ("Mouse-over"), the following additional information is displayed:</p> <p>ECG Name: Name of the ECG.</p> <p>Groups: Group name, if assigned to a DALI group</p>

07 B0 KNX / DALI Gateway Twin N 141/31 983D11
07 B0 KNX / DALI Gateway Twin plus N 141/21 983411
07 B0 KNX / DALI Gateway plus N 141/03 983711

8. Channel

The overview offers a separate and independent working area for each DALI line (channel) for channel A and channel B.

8.1 Channel mode

The DALI channel can be operated in different modes.

Note: When changing the DALI channel mode, all settings (ECG, groups, sensors) for the relevant channel are deleted without prior polling!

Channel A (B)	
Parameters	Settings
DALI channel mode (When changed....)	Disabled Normal mode (bus mode) Broadcast
Normal mode: All available features can be used. Disabled: The DALI channel is switched off, e.g. if only one channel is in use. Broadcast: All connected ECGs are controlled as a group. → see Section 0	

07 B0 KNX / DALI Gateway Twin N 141/31 983D11
 07 B0 KNX / DALI Gateway Twin plus N 141/21 983411
 07 B0 KNX / DALI Gateway plus N 141/03 983711

8.2 Broadcast (Central function)

The DALI channel Broadcast mode controls all connected ECGs simultaneously via the Broadcast commands provided by DALI. The commissioning is significantly reduced, since neither the search is still the individual assignment is necessary. Sensors are not included.

All settings for ECGs, groups and sensors, commissioning and testing functionality lapse in this way for this channel.

Parameters are available for configuration as in a group (see 9.2) (Rise time 0.7s)..

All connected ECGs can be contacted via the communication objects below:

Object name	Function	Type	Flag																
[Channel], broadcast, switching	on/off	1 bit 1.001	CW																
This object switches the DALI channel.																			
[Channel], broadcast, dimming	brighter/darker	4 bit 3.007	CW																
This object receives DALI channel dimming commands.																			
[Channel], broadcast, dimming value	8-bit value	1 byte 5.001	CW																
This object receives a DALI channel dimming value.																			
[Channel], broadcast, dimming value/time	Dimming time + dimming value	3 byte 225.001	CW																
This object receives a DALI channel dimming value with dimming time.																			
<table border="1" style="width: 100%; text-align: center;"> <tr> <td>Bit 23</td><td>22</td><td>21</td><td>20</td><td>19</td><td>18</td><td>17</td><td>16</td> </tr> <tr> <td colspan="8">Dimming time (DPT_TimePeriod100MSec, high byte)</td> </tr> </table>				Bit 23	22	21	20	19	18	17	16	Dimming time (DPT_TimePeriod100MSec, high byte)							
Bit 23	22	21	20	19	18	17	16												
Dimming time (DPT_TimePeriod100MSec, high byte)																			
<table border="1" style="width: 100%; text-align: center;"> <tr> <td>Bit 15</td><td>14</td><td>13</td><td>12</td><td>11</td><td>10</td><td>9</td><td>8</td> </tr> <tr> <td colspan="8">Dimming time (DPT_TimePeriod100MSec, low byte)</td> </tr> </table>				Bit 15	14	13	12	11	10	9	8	Dimming time (DPT_TimePeriod100MSec, low byte)							
Bit 15	14	13	12	11	10	9	8												
Dimming time (DPT_TimePeriod100MSec, low byte)																			
<table border="1" style="width: 100%; text-align: center;"> <tr> <td>Bit 7</td><td>6</td><td>5</td><td>4</td><td>3</td><td>2</td><td>1</td><td>0</td> </tr> <tr> <td colspan="8">Dimming value (DPT_Scaling)</td> </tr> </table>				Bit 7	6	5	4	3	2	1	0	Dimming value (DPT_Scaling)							
Bit 7	6	5	4	3	2	1	0												
Dimming value (DPT_Scaling)																			
[Channel], broadcast, color temperature dimming	Warmer/colder	4 bit 3.007	KS																
This object is used to receive the telegrams for dimming the color temperature of the DALI channel.																			
[Channel], broadcast, color temperature value	16-bit value	2 byte 7.006	KS																
This object is used to receive a color temperature value of the DALI channel.																			

The parameters "Group, status switching", "Group, status dimming value" and "Group, status failure" listed in section **Fehler! Verweisquelle konnte nicht gefunden werden.** are used to decide on automatic sending of status messages. The following communication objects are available.

07 B0 KNX / DALI Gateway Twin N 141/31 983D11
 07 B0 KNX / DALI Gateway Twin plus N 141/21 983411
 07 B0 KNX / DALI Gateway plus N 141/03 983711

Object name	Function	Type	Flag
[Channel], broadcast, status switching	on/off	1 bit 1.001	CRT
This object sends the current DALI channel switching status.			
[Channel], broadcast, status dimming value	8-bit value	1 byte 5.001	CRT
This object acts as the sending object for the current channel status (dimming value).			
[Channel], broadcast, status failure	1 = failure	1 bit 1.005	CRT
This object sends the DALI channel failure status (0 = no failure, 1 = failure). Only lamp failures are detected.			
[Channel], broadcast, status color temperature	16-bit value	2 byte 7.006	KLÜ
This object acts as the sending object for the current DALI channel status (color temperature).			

07 B0 KNX / DALI Gateway Twin N 141/31 983D11
 07 B0 KNX / DALI Gateway Twin plus N 141/21 983411
 07 B0 KNX / DALI Gateway plus N 141/03 983711

9. Groups

9.1 Parameter windows

All available groups are shown in a table for improved visibility. Initially, the table is blank and all necessary groups must be created. Values that are enabled for editing can be edited directly in the table. The usual table editing tools are available (→ 5.4). In addition, parameter settings can be transferred between groups; the group name is retained in this process (→ 5.5).

Groups									
New Edit Delete Copy Paste									
No. ->	Name	Operating mode	Min. dimming value	Max. dimming value	Switch on value	Time 1	Time 2	Value 2	
1	Group 1	Normal mode	10 %	100 %	100 %				
2	Group 2	Normal mode	10 %	100 %	100 %	-	-	-	-
3	Group 3	Normal mode	10 %	100 %	100 %	-	-	-	-
4	Group 4	Normal mode	10 %	100 %	100 %	-	-	-	-
5	Group 5	Normal mode	10 %	100 %	100 %	-	-	-	-
6	Group 6	Normal mode	10 %	100 %	100 %	-	-	-	-
7	Group 7	Normal mode	10 %	100 %	100 %	-	-	-	-
8	Group 8	Normal mode	10 %	100 %	100 %	-	-	-	-
9	Group 9	Normal mode	10 %	100 %	100 %	-	-	-	-
10	Group 10	Normal mode	10 %	100 %	100 %	-	-	-	-
11	Group 11	Normal mode	10 %	100 %	100 %	-	-	-	-
12	Group 12	Normal mode	10 %	100 %	100 %	-	-	-	-
13	Group 13	Normal mode	10 %	100 %	100 %	-	-	-	-
14	Group 14	Normal mode	10 %	100 %	100 %	-	-	-	-
15	Group 15	Normal mode	10 %	100 %	100 %	-	-	-	-
16	Group 16	Normal mode	10 %	100 %	100 %	-	-	-	-

Fig. 9 Group parameters window

Parameters window menu	
New	A new group is added.
Edit	A group's parameters can be edited.
Delete	The marked group(s) is/are deleted.
Copy	The marked group is copied to the clipboard.
Paste	The group from the clipboard is added as a new group. The group name is copied. The group is added at the next free number after the current item.

In addition to parameter editing in the tabular presentation, all parameters in a parameter presentation are also editable.

07 BO KNX / DALI Gateway Twin N 141/31 983D11
 07 BO KNX / DALI Gateway Twin plus N 141/21 983411
 07 BO KNX / DALI Gateway plus N 141/03 983711

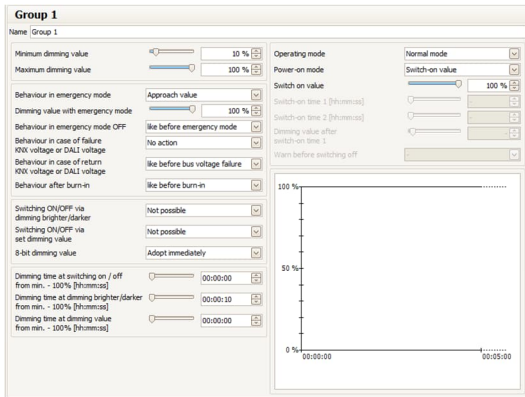

Fig. 10 Parameter window group

9.2 Parameters for group

Channel A (B)	
Groups	
Parameters	Settings
Name (max. 25 characters)	
This parameter assigns a group name with a maximum of 25 characters. This name is used for the communication objects belonging to this group.	
Activate color temperature for the group	
This parameter can be used to activate the color temperature control of a group. Upon activation, the "color temperature" tab is displayed. If the group includes ECGs that do not support color temperature control, these are additional controlled with color temperature control commands but these commands are ignored by the ECGs.	

The following parameters govern the mode and dimming pattern of the group.

Channel A (B)	
Groups	
Parameters	Settings
Mode	Normal mode Normal- / night-mode Constant light Time switch 1-level Time switch 2-level
"Normal-/night-mode": Group is integrated in night mode (→ 4.3.2). "Constant light": The group is switched on permanently at the set switching value. No other parameters can be set. However, status objects are available. "1-level timer mode" or "2-level timer mode": A timer mode can be started by an ON telegram, a dim telegram (brighter/darker) or a dimming value telegram. After switching time 1 or switching time 2 has elapsed, the lights will be dimmed with the dim time configured for switching on via the parameter "Dimming time at switching on / off from min. - 100% [hh:mm:ss]". With the setting "Time switch 2-level", the lighting is dimmed to the interim value (i.e. the dimming value after the switching time 1) has elapsed with the dim time set via the parameter "Dimming time at switching on / off from min. - 100% [hh:mm:ss]".	

07 B0 KNX / DALI Gateway Twin N 141/31 983D11
 07 B0 KNX / DALI Gateway Twin plus N 141/21 983411
 07 B0 KNX / DALI Gateway plus N 141/03 983711

Channel A (B)	
Groups	
Parameters	Settings
<p>Each group control resets the timer. Scene commands end each timer mode. The new value is kept with no time limit.</p>	
Diagram	
The diagram shows the dimming value over time. Right clicking on the diagram copies it to the clipboard.	

07 B0 KNX / DALI Gateway Twin N 141/31 983D11 07 B0 KNX / DALI Gateway Twin plus N 141/21 983411 07 B0 KNX / DALI Gateway plus N 141/03 983711	
Switch-on time 1 [hh:mm:ss]	00:00:00 – 15:00:00 00:02:00
hh= for hours; mm= for minutes; ss= for seconds. Enter the time here after which (with 1-step timer mode), the lighting is switched off or after which the interim dim value should be applied (with 2-step timer mode). After starting timer mode through an on/dim/value telegram, the set switching time 1 begins only after reaching the switch-on dim value.	
Switch-on time 2 [hh:mm:ss]	00:00:00 (= continuous), 00:00:01 – 15:00:00 00:00:30
hh= for hours; mm= for minutes; ss= for seconds. The time is entered here for a 2-step timer mode, which begins after dimming to the dimming value after switching time 1. The group/ECG is then switched off when the time has elapsed.	
Dimming value after switch-on time 1	0%-100% 10%
This parameter determines the interim value that is set after the first step has elapsed. The set value is restricted by the program to the range between the minimum and maximum dimming values. Percentages are rounded values for technical reasons and have an accuracy of approximately $\pm 1\%$. A set dimming value of 0% means that the smallest possible KNX dimming value ($\sim 0.4\%$) is used.	
Warn before switching off	Yes No
This parameter sets whether the group is to signal that it is to be switched off shortly in night mode or 1-step timer mode approximately 30 seconds before switching off by dimming to 50% of the former dimming value or at least 50% of the minimum dimming value.	
Behavior during emergency mode	No action Initiate value
This parameter defines the behavior of the ECG/light when an "Emergency mode ON" telegram is received. In the case of "no action", emergency mode has no effect on this ECG; it continues to be dimmable.	
Dimming value during emergency mode (limited by the minimum/maximum dimming value)	0...100% 100%
In the case of "Initiate value", the dimming value of the ECG/light is determined when an "Emergency mode ON" telegram is received. A set dimming value of 0% means that the smallest possible KNX dimming value ($\sim 0.4\%$) is used.	
Behavior during emergency mode OFF	As before emergency mode Switch on value Maximum dimming value Minimum dimming value Switch off Last received dimming value No change
This parameter defines which dimming value is applied to the group/individual light at the end of emergency mode. If this parameter is set to "switch-on value" and the "switch-on value" of the group/individual light is configured with "last value", then the corresponding group or light is set at the end of emergency mode to the dimming value it had before the start of emergency mode. If the group or light was shut off at the start of emergency mode, then it is set to the minimum dimming value.	
Behavior in case of KNX voltage or DALI voltage failure	No action Switch on value Maximum dimming value Minimum dimming value Dimming value for emergency lighting Switch off
This parameter specifies which dimming value the group should assume after both the KNX bus voltage and the mains power supply at the gateway fail. Also refer to the table on behavior upon recovery →24.3.1	

07 B0 KNX / DALI Gateway Twin N 141/31 983D11
 07 B0 KNX / DALI Gateway Twin plus N 141/21 983411
 07 B0 KNX / DALI Gateway plus N 141/03 983711

Behavior in case of KNX voltage or DALI voltage recovery	No action As before bus voltage failure Switch on value Maximum dimming value Minimum dimming value Switch off Last received dimming value
This parameter determines which dimming value the group should assume after both the KNX bus voltage and the mains power supply at the gateway are again present. Also refer to the table on behavior upon recovery → 24.3.2.	
Behavior after burn-in process	As before burn-in process Switch off Switch on value Maximum dimming value Minimum dimming value No burn-in process possible
This parameter defines which dimming value is applied to the group / ECG after the burn-in process. (→ Section 3.9)	
Switching ON/OFF via dimming brighter/darker	Not possible Switching on possible Switching off possible Switching off/on possible
If a switched off group is to be switched on by receiving a relative dimming value "brighter", this parameter must be set to "Switch-on possible". In this case, the group is always switched on first, the minimum dimming value skipped and then brightened by the received relative dimming value with the set dimming time for dimming brighter/darker. Switch-off via darker dimming is not possible with this setting. If this is to switch off a switched-on group where the brightness is dimmed to a value below the minimum dimming value by dimming, then this parameter must be set to "Switch off possible". Switch-on via brighter dimming is not possible with this setting. If both switching on and off of the group/ECG is to be possible under the above boundary conditions, then this parameter must be set to "Switch on and off possible".	

07 BO KNX / DALI Gateway Twin N 141/31 983D11
 07 BO KNX / DALI Gateway Twin plus N 141/21 983411
 07 BO KNX / DALI Gateway plus N 141/03 983711

Switching On/Off via set dimming value	Not possible On if dimming value \geq minimum dimming value Off if dimming value $<$ minimum dimming value Switching off/on possible On if dimming value $>$ 0% and off if dimming value = 0%
<p>If it is to be possible in the switched off state to switch the group on by receiving a dimming value that is greater than or equal to the minimum dimming value, then this parameter must be set to "On if dimming value \geq minimum dimming value". The group is then switched on and the dimming value, depending on the dimming value configured for dimming value setting, is either skipped or dimmed. If the received dimming value is below the minimum dimming value, then the group remains switched off. Switching off the group via dimming value set is not possible with this setting.</p> <p>If the group is switched on and this parameter is set to "Off for dimming value $<$ min. dimming value", then receiving a telegram with a dimming value $<$ min. dimming value leads to dimming down (with the dimming time configured for dim value setting) to the minimum dimming value and then to switching off of the group. Switching on the group via dimming value set is not possible with this setting. If this parameter is set to "Switch On and Off possible", then the group is switched on if the received dimming value is \geq min. dimming value and switched off if the received dimming value is $<$ min. dimming value.</p> <p>If this parameter is set to "On for dim value $>$ 0% and off for dim value = 0%", then any dim value $>$ 0% leads to switching on of the group. If the dim value is $<$ min. dim value, then the group is dimmed to the minimum dim value. Only after receiving a dim value = 0% is the group switched off.</p>	
8 bit dimming value	Adopt immediately Adopt at ON only
This parameter determines whether the group, if it is in the OFF state, executes (accepts immediately) a dim value telegram received via the bus or saves the dim value and only dims to this value with the next switch-on telegram. The dim value is always accepted immediately if the group is already switched on.	
Minimum dimming value	0...100% 10%
This parameter determines the minimum dim value. With darker dimming, you can only dim to this value. Percentages are rounded values for technical reasons and have an accuracy of approximately \pm 1%. A set dimming value of 0% means that the smallest possible KNX dimming value (\sim 0.4%) is used.	
Maximum dimming value	0...100% 100%
This parameter determines the maximum dim value. With brighter dimming, you can only dim to this value. The percentages are rounded values for technical reasons and are accurate to approximately \pm 1%. A set dimming value of 0% means that the smallest possible KNX dimming value (\sim 0.4%) is used.	
Power-on mode	Off if dimming value $<$ minimum dimming value Last dimming value Dimming value at switch off
<p>This parameter sets the switch on value when receiving an ON telegram.</p> <p><i>Note on setting "last dimming value":</i> When switching off, even if the dim value received earlier is $<$ min. dim value (applies also for the value 0), the lighting always switches to minimum dim value. This applies even if there is no "last received dim value".</p> <p><i>Note on "Dimming value at switch off" setting:</i> When switching on, if there has not yet been a switch on, the lighting is always switched to the minimum dim value.</p>	
Switch on value	0 - 100%
In the case of "Switch on value" switching mode, the value is set here. The configured switch-on value (dim value) is restricted to the range between the minimum and maximum dimming values. Percentages are rounded values for technical reasons and have an accuracy of approximately \pm 1%. A set dimming value of 0% means that the smallest possible KNX dimming value (\sim 0.4%) is used.	

07 B0 KNX / DALI Gateway Twin N 141/31 983D11 07 B0 KNX / DALI Gateway Twin plus N 141/21 983411 07 B0 KNX / DALI Gateway plus N 141/03 983711
--

Switch on value (night)	0 - 100%
In the case of power-on mode "Dimming value day/night" is here the value for the switch-on value for night operation. The parameterized starting value (dimming value) is in the range between the minimum and maximum dimming value limited. The percentage figures are due to technical circumstances rounded values and have an accuracy of approx. +/-1%. A set dimming value of 0% means that the smallest possible KNX dimming value (~0.4%) is used.	
Dimming time for switching on/off from min. -100% [hh:mm:ss]	00:00:00 – 15:00:00 00:00:00
hh= for hours; mm= for minutes; ss= for seconds. This parameter determines the dim time in which the group dims to the switch-on value after an ON or after an OFF telegram to the switch-off value, for which the set dim time applies for a dimming from minimum dim value to 100%. If the setting is 00:00:00, switching on or off is skipped.	
Dimming time for dimming brighter/darker from min. - 100% [hh:mm:ss]	00:00:01 – 15:00:00 00:00:03
hh= for hours; mm= for minutes; ss= for seconds. This parameter determines the time in when dimming brighter/darker is dimmed from minimum dim value to 100%.	
Dimming time at dimming value from min. - 100% [hh:mm:ss]	00:00:00 – 15:00:00 00:00:00
hh= for hours; mm= for minutes; ss= for seconds. This parameter determines the time in which the new value is dimmed after receiving an 8-bit dim value. The set time applies for a dimming process from minimum dim value to 100%. If the setting is 00:00:00, the new dim value is skipped.	

The following parameters control the color temperature of the group.

Channel A (B)	
Groups	
Parameter	Settings
Minimum color temperature	1000...20000K 2700K
This parameter can be used to define the minimum color temperature value that can be reached with "dimming color temperature value" (i.e. the dimming can only go as far down as the minimum color temperature value).	
Maximum color temperature	1000...20000K 6000K
This parameter can be used to define the maximum color temperature value that can be reached with "dimming color temperature value" (i.e. the dimming can only go as far up as the maximum color temperature value).	
Dimming time for dimming the color temperature [hh:mm:ss]	00:00:01 – 01:49:00 00:00:05
hh= for hours; mm= for minutes; ss= for seconds. This parameter is used to set the time for dimming from the minimum color temperature value to the maximum color temperature value in case of manual dimming. This time is calculated proportionally based on the selected dimming step (value difference between the old and new values). This results in different times in which the target value is reached depending on the size of the dimming step.	
Dimming time for color temperature value [hh:mm:ss]	00:00:01 – 01:49:00 00:00:05
hh= for hours; mm= for minutes; ss= for seconds. This parameter is used to set the time in which to dim to a color temperature value. This time is calculated proportionally based on the selected dimming step (value difference between the old and new values). This results in different times in which the target value is reached depending on the size of the dimming step.	

07 BO KNX / DALI Gateway Twin N 141/31 983D11 07 BO KNX / DALI Gateway Twin plus N 141/21 983411 07 BO KNX / DALI Gateway plus N 141/03 983711	
Power-on mode	Color temperature value Color temperature value day/night Last received color temperature value Color temperature value during switch off
This parameter sets the switch on value (color temperature value) when receiving an ON telegram. <i>Note on the "last color temperature value" setting:</i> When switching on, even if the color temperature value received earlier is < minimum color temperature value (applies also to the value 0), the lighting always switches to minimum color temperature value. If no "last color temperature value" is available, the current color temperature is not changed. <i>Note on the "color temperature value at switch off" setting:</i> When switching on, if there has not yet been a switch on, the lighting is always switched to the minimum color temperature value.	
Switch on value	1000 – 20000K
In the "color temperature value" switch on mode, the value is set here. The configured switch-on value (color temperature value) is restricted to the range between the minimum and maximum color temperature values.	
Switch on value (night)	1000 – 20000K
In case of power-on mode "color temperature value day/night," the value for the switch-on value for night operation is set here. The configured switch-on value (color temperature value) is restricted to the range between the minimum and maximum color temperature values.	
Behavior in emergency mode	No action Approach value
This parameter determines the behavior of the ECG/light when an "Emergency mode ON" telegram is received. In the case of "no action," emergency mode has no effect on this ECG; it continues to be dimmable.	
Color temperature in emergency mode (limited by the minimum/maximum color temperature value)	1000...20000K 6000K
In the case of "initiate value," the color temperature value of the ECG/light is determined when an "emergency mode ON" telegram is received.	
Behavior in emergency mode OFF	like before emergency mode Switch on value Last received color temperature value No action According to parameter
This parameter defines which color temperature value is applied to the group/individual light at the end of emergency mode. If this parameter is set to "switch-on value" and the "switch-on value" of the group/individual light is configured with "last value," then the corresponding group or light is set at the end of emergency mode to the color temperature value it had before emergency mode was started. If the group or light was shut off at the start of emergency mode, then it is set to the minimum color temperature value.	
Color temperature in emergency mode OFF (limited by the minimum/maximum color temperature value)	1000...20000K 6000K
In the case of "according to parameter," the color temperature value of the ECG/light is determined when emergency mode ends.	

07 B0 KNX / DALI Gateway Twin N 141/31 983D11
 07 B0 KNX / DALI Gateway Twin plus N 141/21 983411
 07 B0 KNX / DALI Gateway plus N 141/03 983711

Behavior in case of KNX voltage or DALI voltage failure	No action Switch on value Color temperature value for emergency lighting According to parameter
This parameter specifies which color temperature value the group should assume after both the KNX bus voltage and the mains power supply at the gateway fail. Also refer to the table on behavior upon recovery →24.3.1.	
Color temperature in case of KNX voltage or DALI voltage failure (limited by the minimum/maximum color temperature value)	1000...20000K 6000K
For "according to parameter," the color temperature value of the ECG/light on KNX bus voltage or DALI voltage failure is determined here.	
Behavior on KNX voltage or DALI voltage recovery	No action As before bus voltage failure Switch on value Last received color temperature value According to parameter
This parameter determines which color temperature value the group should assume after both the KNX bus voltage and the mains power supply at the gateway are restored. Also refer to the table on behavior upon recovery → 24.3.2.	
Color temperature in case of KNX voltage or DALI voltage recovery (limited by the minimum/maximum color temperature value)	1000...20000K 6000K
For "according to parameter," the color temperature value of the ECG/light on KNX bus voltage or DALI voltage recovery is determined here.	

9.3 Objects per group

The maximum of 64 ECGs per DALI channel can be assigned to one of a maximum of 16 groups per channel and controlled, or distributed at random to the maximum 16 groups.

[Channel] replaced by A or B, [Group] by the group description.

Object name	Function	Type	Flag
[Channel], [Group], switching	on/off	1 bit 1.001	CW
This object switches the channel's group.			
[Channel], [Group], dimming	brighter/darker	4 bit 3.007	CW
This object receives the dimming telegrams of the channel's group.			
[Channel], [Group], dimming value	8-bit value	1 byte 5.001	CW
This object receives a channel group dimming value.			

07 B0 KNX / DALI Gateway Twin N 141/31 983D11
 07 B0 KNX / DALI Gateway Twin plus N 141/21 983411
 07 B0 KNX / DALI Gateway plus N 141/03 983711

[Channel], [Group], dimming value/time	Dimming time + dimming value	3 byte 225.001	CW																
This object receives a channel group dimming value with dimming time.																			
<table border="1"> <tr> <td>Bit 23</td><td>22</td><td>21</td><td>20</td><td>19</td><td>18</td><td>17</td><td>16</td> </tr> <tr> <td colspan="8">Dimming time (DPT_TimePeriod100MSec, high byte)</td> </tr> </table>				Bit 23	22	21	20	19	18	17	16	Dimming time (DPT_TimePeriod100MSec, high byte)							
Bit 23	22	21	20	19	18	17	16												
Dimming time (DPT_TimePeriod100MSec, high byte)																			
<table border="1"> <tr> <td>Bit 15</td><td>14</td><td>13</td><td>12</td><td>11</td><td>10</td><td>9</td><td>8</td> </tr> <tr> <td colspan="8">Dimming time (DPT_TimePeriod100MSec, low byte)</td> </tr> </table>				Bit 15	14	13	12	11	10	9	8	Dimming time (DPT_TimePeriod100MSec, low byte)							
Bit 15	14	13	12	11	10	9	8												
Dimming time (DPT_TimePeriod100MSec, low byte)																			
<table border="1"> <tr> <td>Bit 7</td><td>6</td><td>5</td><td>4</td><td>3</td><td>2</td><td>1</td><td>0</td> </tr> <tr> <td colspan="8">Dimming value (DPT_Scaling)</td> </tr> </table>				Bit 7	6	5	4	3	2	1	0	Dimming value (DPT_Scaling)							
Bit 7	6	5	4	3	2	1	0												
Dimming value (DPT_Scaling)																			
[Channel], [group], color temperature dimming	Warmer/colder	4 bit 3.007	KS																
This object is used to receive the telegrams for dimming the color temperature of the group of the channel.																			
[Channel], [group], color temperature value	16-bit value	2 byte 7.006	KS																
This object is used to receive a channel group color temperature value.																			

9.4 Parameter status messages

General	
Status messages	
Parameters	Settings
Group, status switching	No Send only on read request Send on status change Send on status change/bus voltage recovery
This parameter sets whether a "switching status" communication object should be added for each group and when these objects should be sent. Sending is not automatic if the setting is "send only on read request". Sending of the status on a read request is possible with any parameter setting except the parameter "no". "Send on status change" sends the current status independently via the communication object after a change. The status is not sent automatically when the bus voltage is restored, even if it is changed in accordance with the setting. The setting "Send on status change/bus voltage recovery" automatically sends the current status after a change, as well as independently upon the bus voltage recovery.	
Group, status dimming value	No Send only on read request Send on status change Send on status change/bus voltage recovery
This parameter sets whether a "status dimming value" communication object per group should be added and when these objects should be sent. Sending is not automatic if the setting is "send only on read request". Sending the dimming value on a read request is possible with any parameter setting except the parameter "no". "Send on status change" sends the current dimming value status for its change independently via the communication object. The dimming value is not sent automatically when the bus voltage returns, even if it is changed in accordance with the setting. The "send on status change/bus voltage recovery" setting sends the current dimming status for its change, as well as independently upon bus voltage recovery.	

07 B0 KNX / DALI Gateway Twin N 141/31 983D11
 07 B0 KNX / DALI Gateway Twin plus N 141/21 983411
 07 B0 KNX / DALI Gateway plus N 141/03 983711

General	
Status messages	
Parameters	Settings
Group, status color temperature	No Send only on read request Send status changes Send status changes / bus voltage recovery
<p>This parameter is used to set whether a "color temperature value status" communication object should be added for each group and when these objects should be sent.</p> <p>Sending is not automatic if the parameter setting is "send only on read request." Sending the color temperature value on a read request is possible with any parameter setting except the parameter "no."</p> <p>"Send on status change" sends the current color temperature value status independently via the communication object after a change. The color temperature value is not sent automatically when the bus voltage returns, even if it is changed in accordance with the setting.</p> <p>The setting "send on status change/bus voltage recovery" automatically sends the current color temperature value after a change, as well as independently upon the bus voltage recovery.</p>	
Group, status failure	No Send only on read request Send on status change Send on status change/bus voltage recovery
<p>This parameter sets whether a "status failure" communication object should be added for each group, via which a light failure or a general failure for the group is to be reported and when these objects should be sent.</p> <p>Sending is not automatic if the setting is "send only on read request". Sending of the status on a read request is possible with any parameter setting except the parameter "no".</p> <p>"Send on status change" sends the current status independently via the communication object after a change. The status is not sent automatically when the bus voltage is restored, even if it is changed in accordance with the setting.</p> <p>The setting "Send on status change/bus voltage recovery" automatically sends the current status after a change, as well as independently upon the bus voltage recovery.</p>	
Group, status failure (4-Byte)	No Send only on read request Send on status change Send on status change/bus voltage recovery
<p>This parameter sets whether the communication object "[Channel], [Group], status failure (4-Byte)" should be added for each group, via which can transmit the quantity of ECGs and inverters assigned to this group and the quantity and type of failures that have been detected in this group.</p> <p>Sending is not automatic if the setting is "send only on read request". Sending of the status on a read request is possible with any parameter setting except the parameter "no".</p> <p>"Send on status change" sends the current status independently via the communication object after a change. The status is not sent automatically when the bus voltage is restored, even if it is changed in accordance with the setting.</p> <p>The setting "Send on status change/bus voltage recovery" automatically sends the current status after a change, as well as independently upon the bus voltage recovery.</p>	

07 BO KNX / DALI Gateway Twin N 141/31 983D11
 07 BO KNX / DALI Gateway Twin plus N 141/21 983411
 07 BO KNX / DALI Gateway plus N 141/03 983711

Channel, status failure	No Send only on read request Send on status change Send on status change/bus voltage recovery
<p>This parameter sets whether a "status failure" communication object should be added for each channel, via which an ECG or communication object is to be reported and when the object value should be sent. Sending is not automatic if the setting is "send only on read request". Sending of the status on a read request is possible with any parameter setting except the parameter "no".</p> <p>"Send on status change" sends the current status independently via the communication object after a change. The status is not sent automatically when the bus voltage is restored, even if it is changed in accordance with the setting. The setting "Send on status change/bus voltage recovery" automatically sends the current status after a change, as well as independently upon the bus voltage recovery.</p> <p>Fundamentally, only if there is a status change at ECG level is a telegram sent independently. Changes to a group's status are sent only on a query command.</p>	
Channel, status switching, ECG no. xy	No Send only on read request Send on status change Send on status change/bus voltage recovery
<p>This parameter sets whether a "[Channel], status switching, ECG no. xy" communication object should be added for each group and when these objects should be sent. Sending is not automatic if the setting is "send only on read request". Sending of the status on a read request is possible with any parameter setting except the parameter "no".</p> <p>"Send on status change" sends the current status independently via the communication object after a change. The status is not sent automatically when the bus voltage is restored, even if it is changed in accordance with the setting. The setting "Send on status change/bus voltage recovery" automatically sends the current status after a change, as well as independently upon the bus voltage recovery.</p>	
Channel, status dimming value, ECG no. xy	No Send only on read request Send on status change Send on status change/bus voltage recovery
<p>This parameter sets whether a "[Channel], status dimming value, ECG no. xy" communication object per group should be added and when these objects should be sent. Sending is not automatic if the setting is "send only on read request". Sending the dimming value on a read request is possible with any parameter setting except the parameter "no".</p> <p>"Send on status change" sends the current dimming value status for its change independently via the communication object. The dimming value is not sent automatically when the bus voltage returns, even if it is changed in accordance with the setting.</p> <p>The "send on status change/bus voltage recovery" setting sends the current dimming status for its change, as well as independently upon bus voltage recovery.</p>	

07 BO KNX / DALI Gateway Twin N 141/31 983D11
 07 BO KNX / DALI Gateway Twin plus N 141/21 983411
 07 BO KNX / DALI Gateway plus N 141/03 983711

Channel, status failure, ECG no. xy	No Send only on read request Send on status change Send on status change/bus voltage recovery
<p>This parameter sets whether an "[Channel], status failure, ECG no. xy" communication object should be added for each group, via which a light failure or a general failure for the group is to be reported and when these objects should be sent.</p> <p>Sending is not automatic if the setting is "send only on read request". Sending of the status on a read request is possible with any parameter setting except the parameter "no".</p> <p>"Send on status change" sends the current status independently via the communication object after a change. The status is not sent automatically when the bus voltage is restored, even if it is changed in accordance with the setting.</p> <p>The setting "Send on status change/bus voltage recovery" automatically sends the current status after a change, as well as independently upon the bus voltage recovery.</p>	
Transmission period after state change value [seconds]	1-60 15
<p>"Transmission period after state change value" ensures that, when dimming, a high bus loading is not generated through dimming value status telegrams following shortly behind one another. After a dimming value status telegram has been sent for a group, the next one for this group is sent only after the transmission period has elapsed. Also, a final status telegram is sent if necessary after the dimming process is complete.</p>	

9.5 Objects status messages

The following object exists for each channel:

[Channel] replaced by A or B.

Object name	Function	Type	Flag														
[Channel], status failure	send/request	2 byte	CRT														
<p>This object polls the failure status for all connected ECGs or sends it automatically.</p> <p>The "Channel, status failure" parameter in the "General" parameters window is variable regarding whether and when this object should be sent on detection of a failure.</p> <p>The following bit assignment is also used:</p> <table border="1" style="width: 100%; text-align: center;"> <tr> <td>Bit 15 ... 11</td> <td>10</td> <td>9</td> <td>8</td> </tr> <tr> <td>not used</td> <td>Converter defective</td> <td>ECG defective</td> <td>Lamp defective</td> </tr> </table> <table border="1" style="width: 100%; text-align: center;"> <tr> <td>Bit 7</td> <td>6</td> <td>5 4 3 2 1 0</td> </tr> <tr> <td>Command</td> <td>Address indicator</td> <td>Address indicator</td> </tr> </table> <p>"Command" is to be set to 1 to poll the failure status and to 0 for the response or if the failure status should be sent automatically.</p> <p>"Address indicator" 0 = ECG address, 1 = Group address</p> <p>"Address" contains the number of the DALI ECG as a binary count in the range 0...63, in which the binary count 0 equates to ECG number 1, etc. or the groups with addresses 0...15. Depending on the ECG count, detecting a failure can take up to 96 seconds.</p> <p>"Not used": 0 must always be reserved.</p> <p>"Lamp defective": The light is defective.</p> <p>ECG defective: The ECG is defective.</p> <p>Example: Send failure query from ECG no.</p> <p>1 : 0080(hex) 2 : 0081(hex) ... 64 : 00BF(hex)</p> <p>Response telegram for lamp failure on ECG no. 2: 0101(hex)</p>				Bit 15 ... 11	10	9	8	not used	Converter defective	ECG defective	Lamp defective	Bit 7	6	5 4 3 2 1 0	Command	Address indicator	Address indicator
Bit 15 ... 11	10	9	8														
not used	Converter defective	ECG defective	Lamp defective														
Bit 7	6	5 4 3 2 1 0															
Command	Address indicator	Address indicator															

07 B0 KNX / DALI Gateway Twin N 141/31 983D11
 07 B0 KNX / DALI Gateway Twin plus N 141/21 983411
 07 B0 KNX / DALI Gateway plus N 141/03 983711

[Channel], status switching, ECG no. xy	send/request	1 Byte	CRT
--	---------------------	---------------	------------

The switching status of each attached ECG can be queried or automatically sent via this object. It can be adjusted using the "Channel, status switching, ECG no. xy" parameter in the "General – status messages" window whether and when (upon request, automatically after a change, or upon bus voltage recovery) the current switching status is to be sent via this object. This takes place even with ECG that has been allocated to a group. In the process the following bit allocation is used:

Bit 7	6	5	4	3	2	1	0
reserved	Off/On	[ECG number-1]					

Note: To read the switching status a value containing the ECG number and bits 6 and 7 both set to 1 has to be sent to the corresponding group address.

[Channel], status dimming value, ECG no. xy	send/request	2 Byte	CRT
--	---------------------	---------------	------------

The switching and dimming status of each attached EVG can be queried or automatically sent via this object. It can be adjusted using the "Channel, status dimming value, ECG no. xy" parameter in the "General – status messages" window whether and when (upon request, automatically after a change, or upon bus voltage recovery) the current status information is to be sent via this object. This takes place even with ECG that has been allocated to a group. In the process the following bit allocation is used:

Bit 15	14	13	12	11	10	9	8
1 = status request	On/Off	[ECG number-1]					

Bit 7	6	5	4	3	2	1	0
8-bit value							

Note: To read the switching status a value containing the ECG number and bits 14 and 15 both set to 1 has to be sent to the corresponding group address.

[Channel], status failure, ECG no. xy	send/request	1 Byte	CRT
--	---------------------	---------------	------------

The failure status of each attached ECG can be queried or automatically sent via this object. It can be adjusted via the "Channel, status failure, ECG no. xy" parameter in the "General – status messages" window whether and when this object is to be sent in the event of a detected failure. In the process the following bit allocation is used:

Bit 7	6	5	4	3	2	1	0
ECG failure	Lamp failure	[ECG number-1]					

Bit 0 to bit 5 contain the number of the ECG as a binary number in the 0...63 range, where the binary number 0 corresponds to ECG number 1, etc. The recognition of a failure can, depending on the number of the ECG, last up to 90 seconds.

Note: To read the switching status a value containing the ECG number and bits 6 and 7 both set to 1 has to be sent to the corresponding group address.

07 B0 KNX / DALI Gateway Twin N 141/31 983D11
 07 B0 KNX / DALI Gateway Twin plus N 141/21 983411
 07 B0 KNX / DALI Gateway plus N 141/03 983711

The following objects exist for each group:

[Channel] replaced by A or B, [Group] by the group description.

Object name	Function	Type	Flag
[Channel], [Group], status switching	on/off	1 bit 1.011	CRT
This object sends the current channel switching status. With the configuration "send on status change" or "send on status change/bus voltage recovery": The switching status is sent at the start (when OFF -> ON) or at the end (when On -> OFF) of the dimming process.			
[Channel], [Group], status dimming value	8-bit value	1 byte 5.001	CRT
This object acts as the sending object for the current status (dimming value) of the group of channels. With the configuration "send on status change" or "send on status change/bus voltage recovery": 700ms. The current status is sent after starting a dimming process. Each further dimming status telegram is sent after the "Transmission period after state change" has elapsed. If the current value has not been sent when the dimming process has ended, this is sent immediately.			
[Channel], [Group], status failure	1 = failure	1 bit 1.005	CRT
This object sends the group status (0 = no failure/1 = failure).			

07 B0 KNX / DALI Gateway Twin N 141/31 983D11
 07 B0 KNX / DALI Gateway Twin plus N 141/21 983411
 07 B0 KNX / DALI Gateway plus N 141/03 983711

Object name	Function	Type	Flag																								
[Channel], [Group], status failure (4-Byte)	send/request	4 Byte	CRT																								
<p>This object transmits the quantity of ECG and inverters assigned to this group and the quantity and type of failures that have been detected in this group.</p> <p>This object will be transmitted as set by the parameter "Group, status failure (4-Byte)".</p> <p>The different bytes of this object have the following meaning:</p> <table border="1"> <tr> <td>Bit 31</td> <td>Bit 30</td> <td>Bit 29...Bit 24</td> </tr> <tr> <td>Normal ECG</td> <td>Emergency ECG</td> <td>Number of defective ECG/inverters</td> </tr> </table> <table border="1"> <tr> <td>Bit 23</td> <td>Bit 22</td> <td>Bit 21...Bit 16</td> </tr> <tr> <td>Normal lamp</td> <td>Emergency lamp</td> <td>Number of defective lamps</td> </tr> </table> <table border="1"> <tr> <td>Bit 15</td> <td>Bit 14</td> <td>Bit 13...Bit 8</td> </tr> <tr> <td>Defective in-verter</td> <td>n.a.</td> <td>Number of inverters</td> </tr> </table> <table border="1"> <tr> <td>Bit 7</td> <td>Bit 6</td> <td>Bit 5 ...Bit 0</td> </tr> <tr> <td>n.a.</td> <td>n.a.</td> <td>Number of ECG</td> </tr> </table> <p>"Number of ECG" (bit 0...5) contains the total number of ECG belonging to this group. "n.a." means "not applicable" and is reserved for future use.</p> <p>"Number of inverters" (bit 8...13) contains the number of inverters of self-contained emergency ECG belonging to this group. "Defective inverter" (bit 15) signals (if set to the logical value "1") that there is at least one defective inverter in this group.</p> <p>"Number of defect lamps" (bit 16...21) contains the number of lamps that have been detected as defective in this group. "Emergency lamp" (bit 22) signals (if set to the logical value "1") that there is at least one defective emergency lamp. "Normal lamp" (bit 23) signals (if set to the logical value "1") that there is at least one defective "normal" lamp.</p> <p>"Number of defective ECG / inverters" (bit 24...29) contains the number of ECG and inverters that have been detected as defective in this group. "Emergency ECG" (bit 30) signals (if set to the logical value "1") that there is at least one emergency ECG with a defective ECG. "Normal ECG" (bit 31) signals (if set to the logical value "1") that there is at least one normal ECG with a defective ECG.</p>				Bit 31	Bit 30	Bit 29...Bit 24	Normal ECG	Emergency ECG	Number of defective ECG/inverters	Bit 23	Bit 22	Bit 21...Bit 16	Normal lamp	Emergency lamp	Number of defective lamps	Bit 15	Bit 14	Bit 13...Bit 8	Defective in-verter	n.a.	Number of inverters	Bit 7	Bit 6	Bit 5 ...Bit 0	n.a.	n.a.	Number of ECG
Bit 31	Bit 30	Bit 29...Bit 24																									
Normal ECG	Emergency ECG	Number of defective ECG/inverters																									
Bit 23	Bit 22	Bit 21...Bit 16																									
Normal lamp	Emergency lamp	Number of defective lamps																									
Bit 15	Bit 14	Bit 13...Bit 8																									
Defective in-verter	n.a.	Number of inverters																									
Bit 7	Bit 6	Bit 5 ...Bit 0																									
n.a.	n.a.	Number of ECG																									
[Channel], [group], status color temperature	16-bit value	2 byte 7.006	KLÜ																								
<p>This object acts as the sending object for the current status (color temperature value) of the group of channels. The current status is sent after starting a dimming process. Each further color temperature status telegram is sent after the "transmission period after state change" has elapsed. If the current value has not been sent when the dimming process has ended, this is sent immediately.</p>																											

07 BO KNX / DALI Gateway Twin N 141/31 983D11
 07 BO KNX / DALI Gateway Twin plus N 141/21 983411
 07 BO KNX / DALI Gateway plus N 141/03 983711

9.6 Status /failure message

All of the current lighting group brightness states are saved in the device. These should be interpreted as target values for the ECG at the current point in time. This value is forced on the ECG and must therefore be its current status after the dimming time has elapsed (0.7 seconds in the normal dimming process). If it is established that the ECG has not assumed the value after multiple transmissions, an ECG failure is reported.

Failures are detected by cyclical polling of the ECG status.

9.7 Disable failure status messages

ECGs are disconnected from DALI in connection with the emergency lighting test. The gateway evaluates this disconnection as an ECG failure and thus also sends failure telegrams via KNX. The sending of failure messages can be disabled to prevent this unnecessary information.



Object name	Function	Type	Flag
Disable failure status messages	1=disable, 0=enable	1 bit 1.003	CW
Setting this object to the value "1" suppresses the sending of the following objects: "[Channel], DALI device failure" "[Channel], status failure" "[Channel], status failure, ECG Nr. xy" "[Channel],[Group], status failure" "[Channel], [Group], status failure (4-Byte)" "[Channel], [ECG], status failure" "[Channel], [ECG], status failure (1-Byte)"			
The failure evaluation continues to be performed. After "0" is received, the status messages are sent based on the current status and the last status sent. (i.e. no telegram is sent if a failure was present during the block).			
The current failure status can be queried by the object "[Channel], status failure" during the block.			
When queried, the other three objects supply the last sent value before the block.			
The object value is set to "0 = enabled" following a mains power failure.			

General	
Status messages	
Parameters	Settings
Switch-on time of the blocking of failure status messages [mm:ss] (0 = indefinite)	00:00 – 59:59 00:00
mm= for minutes; ss= for seconds.	
The time period, after which the block of the failure status messages is automatically withdrawn.	

07 B0 KNX / DALI Gateway Twin N 141/31 983D11
 07 B0 KNX / DALI Gateway Twin plus N 141/21 983411
 07 B0 KNX / DALI Gateway plus N 141/03 983711

10. ECG

The ECGs for the relevant channel are managed in this parameter window. Both a tabular view and a detailed view of each individual ECG are available.

The maximum number of ECGs is dependent on the number of all DALI devices per channel, ECGs and sensors (see 11.1). All ECGs for direct selection are listed in the parameter pages overview. Each ECG is also shown in the assigned group with a group symbol G1 - G16 (e.g.  = G6). The  symbol is displayed if the ECG is not assigned to a group. Groups can be assigned either in the table, the detailed presentation or in the parameter pages overview.

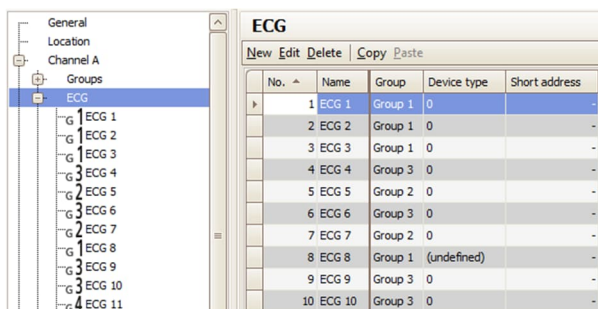

Fig. 11 ECG parameters window

Parameters window menu	
New	A new ECG is added.
Edit	The parameters of an ECG can be edited.
Delete	The marked ECG(s) is/are deleted.
Copy	The marked ECG is copied to the clipboard.
Paste	The ECG from the clipboard is added as a new ECG.

07 B0 KNX / DALI Gateway Twin N 141/31 983D11
 07 B0 KNX / DALI Gateway Twin plus N 141/21 983411
 07 B0 KNX / DALI Gateway plus N 141/03 983711

These parameters are available for ECGs.

Channel A (B)	
ECG	
Parameters	Settings
No.	
ECG serial number from 1 - 64	
Name	
This parameter assigns an ECG a name with a maximum of 25 characters.	
Group	
This parameter assigns the ECG to a group. In this case, entry of all subsequent parameters (except device coding and device type) is disabled, because the group settings are then assigned to the ECG automatically.	

The group assignment can be made inside the overview. To do this, drag the ECG to the desired group.

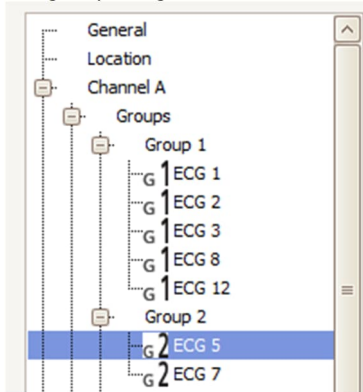

Fig. 12 Group assignment overview

10.1 Device parameters

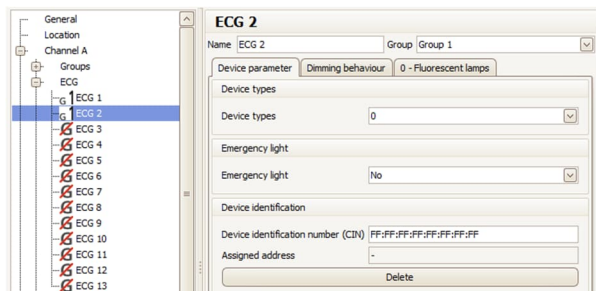

Fig. 13 Device parameters

07 B0 KNX / DALI Gateway Twin N 141/31 983D11
 07 B0 KNX / DALI Gateway Twin plus N 141/21 983411
 07 B0 KNX / DALI Gateway plus N 141/03 983711

Channel A (B)																															
ECG																															
Parameters	Settings																														
Devices																															
<p>ECGs are offered in various device types. When creating an ECG, you can select none, one or a number of types. Type 0 is used as the standard.</p> <table border="1" style="width: 100%; border-collapse: collapse; margin: 10px 0;"> <thead> <tr> <th style="width: 10%;">Type</th> <th style="width: 70%;">Device type</th> <th style="width: 20%;">Ignition time</th> </tr> </thead> <tbody> <tr> <td>0</td> <td>Fluorescent lamp</td> <td>0.7 s</td> </tr> <tr> <td>1</td> <td>Single-battery lights</td> <td>0 s</td> </tr> <tr> <td>2</td> <td>Discharge lamps</td> <td>0 s</td> </tr> <tr> <td>3</td> <td>Low-voltage halogen lamps</td> <td>0 s</td> </tr> <tr> <td>4</td> <td>Incandescent lamps (dimmer)</td> <td>0 s</td> </tr> <tr> <td>5</td> <td>10V converter</td> <td>0 s</td> </tr> <tr> <td>6</td> <td>LED modules</td> <td>0 s</td> </tr> <tr> <td>7</td> <td>Switching function</td> <td>0 s</td> </tr> <tr> <td>8</td> <td>Color control</td> <td>0 s</td> </tr> </tbody> </table> <p>The assignment is only possible when the device types are identical. The device type is used for the assignment can be automatically adjusted when the option in the menu "Options" has been selected accordingly (see 21.1.4). If an ECG has an "Assigned address", the device type cannot be changed. An ECG that is not assigned a type (undefined) supports the basic features (switching, dimming, status). An ECG can be assigned a number of types, which is how the type 0xff (generic) is supported. The maximum ignition time for the implemented device types is used for ECGs of the device type 0xff. If there are ECGs of different types in a group, the maximum ignition time is used.</p>		Type	Device type	Ignition time	0	Fluorescent lamp	0.7 s	1	Single-battery lights	0 s	2	Discharge lamps	0 s	3	Low-voltage halogen lamps	0 s	4	Incandescent lamps (dimmer)	0 s	5	10V converter	0 s	6	LED modules	0 s	7	Switching function	0 s	8	Color control	0 s
Type	Device type	Ignition time																													
0	Fluorescent lamp	0.7 s																													
1	Single-battery lights	0 s																													
2	Discharge lamps	0 s																													
3	Low-voltage halogen lamps	0 s																													
4	Incandescent lamps (dimmer)	0 s																													
5	10V converter	0 s																													
6	LED modules	0 s																													
7	Switching function	0 s																													
8	Color control	0 s																													
Emergency light	No supply by a central battery																														
<p>This parameter selection is always faded in when the DALI device type "1= single-batter emergency light" is not chosen. This parameter can be used to designate a light as an emergency light, whose power is supplied in an emergency lighting case by a central battery or other emergency power supply.</p>																															
Emergency light	Single-battery emergency light with 1 DALI device Single-battery emergency light with 1 DALI device (no dimming) Single-battery emergency light with 2 DALI devices																														
<p>This parameter selection is always faded in when the DALI device type "1= single-batter emergency light" is chosen. This parameter can be used to designate a single-battery emergency light as a single-battery emergency light with one or two DALI devices. In case of "no dimming" the related communication objects will not be displayed.</p>																															
Device identification number (CIN)	16-digit identification number																														
<p>OSRAM assigns a unique 16-digit identification number (CIN = Chip Identification Number) to every DALI device at the factory. This number can be entered here and can be used to directly address the device during commissioning. To make input easier, this identification number is entered as 8 two-digit numbers.</p>																															
Device assignment																															
<p>The ECG's "assigned address" is shown in this field if it is already associated with a commissioning. If the ECG includes an "Assigned address", the device type cannot be changed. "Delete" is used to delete the assignment and restore the CIN.</p>																															
Assigned address																															
<p>This gives the DALI subscriber's currently assigned DALI short address. This is the currently assigned DALI short address of the DALI-subscriber as hexadecimal and decimal number: e.g. 0x0(0), 0x1(1),..., 0xa(10), 0xb(11), ... 0xfe(3F).</p>																															

07 B0 KNX / DALI Gateway Twin N 141/31 983D11
 07 B0 KNX / DALI Gateway Twin plus N 141/21 983411
 07 B0 KNX / DALI Gateway plus N 141/03 983711

10.2 Dimming behavior

The following parameters control the dimming behavior of the ECG and are described in detail in Section 9.2.

An ECG assigned to a group may only be edited in the group.

10.3 Device type 0 - Fluorescent lamp

The following parameters are additionally offered for device type 0:

Channel A (B)	
ECG	
Parameters	Settings
Fluorescent lamp	without auxiliary function with brightness controller
If a brightness sensor is directly connected to the ECG for local brightness control by the ECG, then brighter/darker dimming shifts the target value if this parameter is set to "with brightness control". This target value shift is only effective until the light is switched off. The target value set for the brightness control is used when the light is switched on again.	

The following parameters are disabled if the local brightness controller is activated for a device type 0.

	without auxiliary function	with brightness controller
Minimum dimming value	-	-
Maximum dimming value	-	-
Mode	-	X
Switch-on time 1	-	X
Switch-on time 2	-	X
Dimming value after switch-on time 1	-	X
Warn before switching off	-	X
Behavior in case of KNX voltage or DALI voltage failure	-	X
Behavior in case of KNX voltage or DALI voltage recovery	-	X
Switching ON/OFF via dimming brighter/darker	-	X
Switching On/Off via set dimming value	-	X
8 bit dimming value	-	X
Switch on value	-	X
Dimming value during emergency mode	-	X
Dimming time when switching on/off from min. -100% [hh:mm:ss]	-	X
Dimming time for brighter/darker dimming from min. -100% [in seconds]	-	X
Dimming time for setting the dimming value from min. - 100% [hh:mm:ss]	-	X

- = no influence of the "Fluorescent lamp" parameter on the activation of the parameter given in the line.

X = the parameter given in the line is disabled when the "fluorescent lamp" parameter is set accordingly.

07 B0 KNX / DALI Gateway Twin N 141/31 983D11
 07 B0 KNX / DALI Gateway Twin plus N 141/21 983411
 07 B0 KNX / DALI Gateway plus N 141/03 983711

10.4 Device type 1 – Emergency light with single battery

The gateway supports ECGs in emergency lights. If battery-operated emergency lights contain two DALI devices (an upstream device and a converter, both with DALI interface), then up to 32 emergency lights with single batteries can be connected for each channel. The gateway automatically detects whether an emergency light contains two or just one DALI device. Both "normal" lights and battery-operated emergency lights may be connected in combination, whereby the max. permissible number of 64 DALI devices per channel, however, may not be exceeded.

An object can be used to start the self-test of every single converter and to send the test result or save it internally. The "Start test" object can be started or queried for each test which is to be started or has been started (function test, partial endurance test or endurance test). At the end of the test, the 3-byte object can be used to automatically report or query the "test result" or to store it in the internal memory for test results.

Not all of the parameters, the parameters are of all ECG from different manufacturers supported because there are optional parameters.

10.4.1 Configuration

Channel A (B)	
ECG	
Parameters	Settings
Dimming value converter in emergency mode	0-100% 100%
This parameter defines which dimming value is assigned to an emergency light when a mains power failure occurs on the converter. The value set by this parameter is loaded into the converter of an emergency light with single battery and saved there. A set dimming value of 0% means that the smallest possible KNX dimming value (~0.4%) is used.	
Converter delay time	00-20 (0.5 min steps) 0
This parameter defines how long the lamp's battery operation should continue following restoration of the mains power supply. The value set by this parameter is loaded into the converter of an emergency light with single battery and saved there.	
Partial endurance test interval (weeks)	0 (=never), 1-27 0
This parameter defines the time interval between two partial endurance tests. This value is saved in the gateway so that it monitors the time interval and starts the test accordingly. After this parameter is loaded to the gateway, the partial endurance test is automatically started for the first time after this time interval has expired. If this parameter is set to "0" (= never), then no partial endurance test will be performed.	
Length of the partial endurance test (min)	5-60 45
This parameter is not visible unless the interval > 0 weeks is selected. This defines the length of a partial endurance test. This parameter is used by the gateway to start the partial endurance test. Once this parameter has been loaded the partial endurance test is started when this time interval has passed for the first time. If this parameter is set to "0" (= never), then no partial endurance test will be performed.	
Endurance test interval (weeks)	0 (=never), 1-52 52
This parameter defines the time interval between two endurance tests. This parameter is loaded to the converter of an emergency light operated by single battery. After this parameter is loaded to the converter, the function test is automatically started for the first time after the delay time has expired. The delay time is distributed linearly across the time interval. This distribution depends on the ECG number. If this parameter is set to "0" (= never), then no endurance test will be performed.	
Function test interval (days)	0 (=never), 1-28 8
This parameter defines the time interval between two function tests. This parameter is loaded to the converter of an emergency light operated by single battery. After this parameter is loaded to the converter, the function test is automatically started for the first time after the delay time has expired. The delay time is distributed linearly across the time interval. This distribution depends on the ECG number. If this parameter is set to "0" (= never), then no function test will be performed.	

07 B0 KNX / DALI Gateway Twin N 141/31 983D11
 07 B0 KNX / DALI Gateway Twin plus N 141/21 983411
 07 B0 KNX / DALI Gateway plus N 141/03 983711

10.4.2 Test control

The gateway determines the status of the emergency light ECG at routine intervals and thus records whether an emergency light ECG is planning or performing a test or whether it has ended one. An emergency light ECG can start the function and endurance test independently. The partial endurance test is started by the Gateway. In addition to this, the tests can also be started by an object. The following object is available to start the test and to query the current status:

Object name		Function	Type	Flag			
[Channel], [ECG], Test		start/status	1 byte	CRTS			
This object can be used to start and query a test of the channel's emergency light with single battery and to send it automatically depending on the configuration. The file format has the following meaning:							
Bit 7	6	5	4	3	2	1	0
1= query active	1=query	1=active	1=start	1=active	1=start	1=active	1=start
Battery status		Endurance test		Partial endurance test		Function test	
The gateway ignores every attempt to write to the bits 1, 3, 5 and 7 and to telegrams, for which more than just one of the bits 0, 2, 4 or 6 are set to logical "1" and for which all of the bits are set to logical "0".							

The object's sending behavior is set by the following parameter:

General	
Emergency lighting test mode	
Parameter	Settings
ECG test	Send only on read request Send on status change
With the parameter setting "send only on read request", the current value of the "[Channel], Test" objects are only sent when a read request is received. With the parameter setting "send on status change", the current value of the "[Channel], Test" objects are automatically sent when a change has occurred. The status is not sent automatically when the bus voltage is restored, even if it is changed in accordance with the setting.	

07 B0 KNX / DALI Gateway Twin N 141/31 983D11
 07 B0 KNX / DALI Gateway Twin plus N 141/21 983411
 07 B0 KNX / DALI Gateway plus N 141/03 983711

10.4.3 Test results

After the gateway determines that a test has ended, the result is queried by the ECG and sent by the following object:

Object name		Function	Type	Flag			
[Channel], [ECG], Test result		Send/query	3 byte	CRT			
The test result of the converter of an emergency light with single battery is queried and automatically sent by this object. The "send test result" parameter defines whether and when the test result should be sent. The individual data have the following meaning:							
Bit 23	22	21	20	19	18	17	16
Test result							
Bit 16...23 "Test result": This byte contains the charging status of the battery as a value from 0 to 254 (= 0...100%) at the end of a function test or at the end of a battery status query. In case of value 255 the current battery status is not available. At the end of an endurance test, it contains either the duration (as a multiple of 2 minutes) of the successful endurance test (Bit 3 = 0) or the time after which the battery was prematurely drained (Bit 3 = 1).							
Bit 15	14	13	12	11	10	9	8
Failure		Time exceeded		Defective		Battery service life too short	Converter defective
Operational-endurance test	Function test	Endurance test	Function test	Lamp	Battery		
Bit 8 "Converter defective": a hardware failure was detected.							
Bit 9 "Battery service life too short": the battery was drained before the end of its calculated service life.							
Bit 10 "Battery failure": reports a missing or excessively low battery voltage.							
Bit 11 "Emergency lamp defective": reports that the light connected to the converter is defective.							
Bit 12 "Time function test exceeded": the function test could not be performed within the specified time period.							
Bit 13 "Endurance test time exceeded": The endurance test could not be performed within the specified time period.							
Bit 14 "Failure during function test": reports a failure detected during the function test.							
Bit 15 "Failure during endurance test": reports a failure detected during the endurance test.							
Bit 7	6	5	4	3	2	1	0
not used	not used	not used	End of battery query	Test failure	End		
					Endurance test	Partial endurance test	Function test
Bit 0 logical "1": End of a function test.							
Bit 1 logical "1": End of a partial endurance test.							
Bit 2 logical "1": End of an endurance test.							
Bit 3 logical "1": a failure occurred during the test. Bits 8 to 15 then contain the failure data.							
Bits 8 to 15 are set to logical "0" when the test is flawless.							
Bit 4 logical "1": End of the battery query.							
"n.u." stands for "not used" and is reserved for future usage. This bit is always set to 0.							

The following parameter can be used to set whether this object is automatically sent:

General	
Emergency lighting test mode	
Parameter	Settings
ECG test result	Send only on read request at the end of the test
With the parameter setting "send test result: only on read request", the current value of the "Test result" objects are only sent when a read request is received. With the parameter setting "send test result: at end of test", the current value of the "Test result" objects are automatically sent at the end of the test.	

As an alternative, the following object is provided one time per line.

07 BO KNX / DALI Gateway Twin N 141/31 983D11
 07 BO KNX / DALI Gateway Twin plus N 141/21 983411
 07 BO KNX / DALI Gateway plus N 141/03 983711

Object name	Function	Type	Flag				
[Channel], test result expanded	send/request	10 byte	CRT				
The test result of the converter of a battery-operated emergency light can be queried and automatically sent by this object. The different possible settings of the "send test result" parameter define whether and when the test result should be sent. The individual bits have the following meaning:							
Bit 79	78	77	76	75	74	73	72
not used	not used	[ECG Number 1]					
Bits 72...77: contain the number of the DALI-ECG as a binary number in the range 0...63, whereby "0" corresponds to the ECG number 1, etc.							
Bit 71	70	69	68	67	66	65	64
not used	not used	not used	Day				
Bit 63	62	61	60	59	58	57	56
not used	not used	not used	Month				
Bit 55	54	53	52	51	50	49	48
not used	Year						
Bits 48 ...71 Day of the test end in accordance with data point type "date"							
Bit 47	46	45	44	43	42	41	40
Weekday				Hours			
Bit 39	38	37	36	35	34	33	32
not used	not used	Minutes					
Bit 31	30	29	28	27	26	25	24
not used	not used	Seconds					
Bits 24 ...47 Time of the test end in accordance with data point type "time"							
Bit 23	22	21	20	19	18	17	16
Test result							
Bits 16...23 "Test result": This byte contains the charging status of the battery as a value from 0 to 255 (= 0...100%) at the end of a function test or at the end of a battery status query. In case of value 255 the current battery status is not available. At the end of an endurance test, it contains (as a multiple of 2 minutes) either the duration of the successful endurance test (Bit 3 = 0) or the time after which the battery was prematurely drained (Bit 3 = 1).							
Bit 15	14	13	12	11	10	9	8
Failure in the endurance test	Failure in the function test	Time of the endurance test exceeded	Time of the function test exceeded	Emergency lamp defective	Battery defective	Battery service life too short	Converter defective
Bit 8 "Converter defective": a hardware failure was detected. Bit 9 "Battery service life too short": the battery was drained before the end of its calculated service life. Bit 10 "Battery failure": reports a missing or excessively low battery voltage. Bit 11 "Emergency lamp defective": reports that the light connected to the converter is defective. Bit 12 "Function test time exceeded": The function test could not be performed within the specified time period. Bit 13 "Endurance test time exceeded": The endurance test could not be performed within the specified time period. Bit 14 "Failure during function test": reports a failure detected during the function test. Bit 15 "Failure during endurance test": reports a failure detected during the endurance test.							

07 B0 KNX / DALI Gateway Twin N 141/31 983D11
 07 B0 KNX / DALI Gateway Twin plus N 141/21 983411
 07 B0 KNX / DALI Gateway plus N 141/03 983711

Object name				Function	Type	Flag	
Bit 7	6	5	4	3	2	1	0
not used	not used	not used	End Battery query	Test failure	End Endurance test	End Partial endurance test	End Function test
Bit 0 logical "1": End of a function test. Bit 1 logical "1": End of a partial endurance test. Bit 2 logical "1": End of an endurance test. Bit 3 logical "1": a failure occurred during the test. Bits 8 to 15 then contain the failure data. Bits 8 to 15 are set to logical "0" when the test is flawless. Bit 4 logical "1": End of the battery query. "n.u." stands for "not used" and is reserved for future usage. This bit is always set to 0.							

The following parameter can be used to set whether this object is automatically sent:

General	
Emergency lighting test mode	
Parameter	Settings
Expanded test result	Send only on read request Send at end of test
With the parameter setting "send expanded test result: never", the "Test result expanded" object is faded out. With the parameter setting "send expanded test result: at end of test", the current value of the "Test result" objects is automatically sent at the end of the test.	

10.4.4 Record test results

The gateway is able to internally store test results from tests of the emergency light ECG. A total of 897 test results can be saved. This corresponds to the test results of six function tests and an endurance test for 128 emergency light ECGs.

A memory entry represents the result of a test of an emergency light ECG. The results of tests initiated by the "[Channel], Test" object are saved. Battery queries are not saved. The results can be read and deleted.

The following communication objects are provided to query the number of free storage spaces and to detect a possible memory overflow:

Object name	Function	Type	Flag
Test results, storage space status	1 = Threshold fallen short of	1 bit 1.005	CRT
Depending on the configuration, this object sends the value 1 when the threshold for free storage spaces is fallen short of. The value 0 is sent when the threshold is exceeded.			
Test results, free storage spaces	call up	2 byte	CRT
Depending on the configuration, this object sends the number of free storage spaces.			

07 B0 KNX / DALI Gateway Twin N 141/31 983D11
 07 B0 KNX / DALI Gateway Twin plus N 141/21 983411
 07 B0 KNX / DALI Gateway plus N 141/03 983711

The following parameters can be used to set the behavior of the objects named above.

General	
Emergency lighting test mode	
Parameters	Setting
Record test results	Yes No
This parameter enables the recording of the test results in the internal memory and enables the associated objects and parameters for display. The "Emergency lighting test results" node, which enables the usage of the internal memory, is additionally faded in the parameter overview.	
Test results, storage space status	No Send only on read request Send on status change Send on status change/bus voltage recovery
This parameter is used to set whether a "Test results, storage space status" object is displayed. If the parameter setting is "send on status change", the object is sent automatically on each status change. With "send on status change / bus voltage recovery", the object is sent when the bus voltage returns if it was changed before the return of the bus voltage. Sending is not automatic with "send only on read request". Sending the status on a read request is possible with any parameter setting except the parameter "no".	
Test results, free storage spaces	No Send only on read request Send on status change Send on status change and exceeded threshold Send on status change/bus voltage recovery
This parameter sets whether a "Test results, free storage spaces" object is displayed, which is used to report the number of free storage spaces for test results. If the parameter setting is "send on status change", the object is sent automatically on each status change. The "Send on status change and exceeded threshold" parameter setting is used to send the object automatically whenever a status change occurs if the set threshold for the free storage spaces has been fallen short of. With "send on status change/bus voltage recovery", the object is sent when the bus voltage returns if it was changed before the return of the bus voltage. Sending is not automatic with "send only on read request". Sending the status on a read request is possible with any parameter setting except the parameter "no".	
Threshold for free storage spaces	0 – 897 100
This parameter sets a threshold value for which a failure indicating that very little memory is free for test results is reported in the device's information display when this value is fallen short of. Depending on the configuration, a telegram is additionally sent by a "Test results, storage space status" object.	

If no more free storage spaces are available, then the entries are written over on a rolling basis, i.e. the oldest entries are written over first and thus deleted.

07 B0 KNX / DALI Gateway Twin N 141/31 983D11
 07 B0 KNX / DALI Gateway Twin plus N 141/21 983411
 07 B0 KNX / DALI Gateway plus N 141/03 983711

10.4.5 Emergency lighting test results

The "Emergency lighting test results" node is faded in the parameter overview following activation of the "Record test results" function on the "General" parameters page.

This is used to manage the internal memory in the gateway.

Parameters window menu	
Update	This button is used to read the internal memory, with a KNX connection to the gateway being required for this. The data do not remain saved after the parameter page is changed or the plug-in ended.
Save	This enables the read test results to be saved and archived in an MS Excel file (.xlsx).
Delete	This enables all saved test results to be deleted in the gateway. A warning is displayed before deletion.
Saved test results	The number of currently saved test results is displayed here.
Free storage spaces	The number of storage spaces still free for test results is displayed here. This matches to the value determined by the corresponding object and is used to monitor the threshold.
The test results are written over in [Months]	The time period until the memory writes over the oldest entries is estimated here. No consideration is given as to whether the memory is already partially full.

07 B0 KNX / DALI Gateway Twin N 141/31 983D11
 07 B0 KNX / DALI Gateway Twin plus N 141/21 983411
 07 B0 KNX / DALI Gateway plus N 141/03 983711

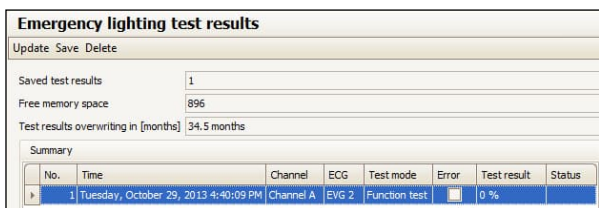

Fig. 14 Parameters window of emergency lighting test results

Columns	
No.	Consecutive number of the entries
Time	Time stamp of the received test result. This information is only available if the gateway was able to receive the current time and date via the time/date objects.
Channel	Current channel
ECG	Name of the ECG
Type of test	Type of test used: Function test, endurance test, etc.
Failure	Failure present <input checked="" type="checkbox"/> , no failure present <input type="checkbox"/>
Test result	This table contains the battery charging status (0...100%) at the end of a function test. At the end of an endurance test, this contains either the duration (minutes) of the successful endurance test (Bit 3 = 0) or the time after which the battery was prematurely drained (Bit 3 = 1).
Status	The status is given here if an failure occurs: Battery service life too short Battery defective Converter defective Failure with the service life Time of the endurance test exceeded Emergency lamp defective Failure with the function test Time of the function test exceeded
ECG No.	The ECG No. can be optionally displayed
Raw data	The data content is transferred here, as in the "[Channel], test result" object
Test result raw data	The data content is transferred here, as in the "[Channel], test result expanded" object.

10.5 Device type 8 - color control

The following parameters control the color temperature of the ECG and are described in detail in section 9.2. An ECG assigned to a group may only be edited in the group.

07 BO KNX / DALI Gateway Twin N 141/31 983D11
 07 BO KNX / DALI Gateway Twin plus N 141/21 983411
 07 BO KNX / DALI Gateway plus N 141/03 983711

10.6 Objects

The following objects exist for each ECG:

Object name	Function	Type	Flag																
[Channel], [ECG], switching	on/off	1 bit 1.001	CW																
This object switches the channel's ECG.																			
[Channel], [ECG], dimming	brighter/darker	4 bit 3.007	CW																
This object receives dimming telegrams of the Channel's ECG.																			
[Channel], [ECG], dimming value	8-bit value	1 byte 5.001	CW																
This object receives a channel ECG dimming value.																			
[Channel], [ECG], dimming value/time	Dimming time + dimming value	3 byte 225.001	CW																
This object receives a channel ECG dimming value with dimming time.																			
<table border="1"> <tr> <td>Bit 23</td><td>22</td><td>21</td><td>20</td><td>19</td><td>18</td><td>17</td><td>16</td> </tr> <tr> <td colspan="8">Dimming time (DPT_TimePeriod100MSec, high byte)</td> </tr> </table>				Bit 23	22	21	20	19	18	17	16	Dimming time (DPT_TimePeriod100MSec, high byte)							
Bit 23	22	21	20	19	18	17	16												
Dimming time (DPT_TimePeriod100MSec, high byte)																			
<table border="1"> <tr> <td>Bit 15</td><td>14</td><td>13</td><td>12</td><td>11</td><td>10</td><td>9</td><td>8</td> </tr> <tr> <td colspan="8">Dimming time (DPT_TimePeriod100MSec, low byte)</td> </tr> </table>				Bit 15	14	13	12	11	10	9	8	Dimming time (DPT_TimePeriod100MSec, low byte)							
Bit 15	14	13	12	11	10	9	8												
Dimming time (DPT_TimePeriod100MSec, low byte)																			
<table border="1"> <tr> <td>Bit 7</td><td>6</td><td>5</td><td>4</td><td>3</td><td>2</td><td>1</td><td>0</td> </tr> <tr> <td colspan="8">Dimming value (DPT_Scaling)</td> </tr> </table>				Bit 7	6	5	4	3	2	1	0	Dimming value (DPT_Scaling)							
Bit 7	6	5	4	3	2	1	0												
Dimming value (DPT_Scaling)																			
[Channel], [ECG], status switching	on/off	1 bit 1.011	CRT																
This object sends the current switching status.																			
[Channel], [ECG], status dimming value	8-bit value	1 byte 5.001	CRT																
This object acts as the sending object for the current status (dimming value) of the ECGs.																			
[Channel], [ECG], status failure	1 = failure	1 bit 1.005	CRT																
This object sends the ECG status (0 = no failure/1 = failure).																			
[Channel], [ECG], Status failure	send/request	1 byte	CRT																
This object sends a message if the lamp, ECG (switching device) or the converter is defective. The sending is according to the setting of the parameter "ECG, status failure code" (see "General - Parameter window objects").																			
The individual bits have the following meaning:																			
<table border="1"> <tr> <td>Bit 7</td><td>6</td><td>5</td><td>4</td><td>3</td><td>2</td><td>1</td><td>0</td> </tr> <tr> <td>n.a.</td><td>n.a.</td><td>n.a.</td><td>n.a.</td><td>n.a.</td><td>Converter defective</td><td>ECG defective</td><td>Lam defective</td> </tr> </table>				Bit 7	6	5	4	3	2	1	0	n.a.	n.a.	n.a.	n.a.	n.a.	Converter defective	ECG defective	Lam defective
Bit 7	6	5	4	3	2	1	0												
n.a.	n.a.	n.a.	n.a.	n.a.	Converter defective	ECG defective	Lam defective												
"Lamp defective": The lamp is defective.																			
"ECG defective": The ECG (switching devices) is defective.																			
"Converter defective": The converter is defective.																			
"n.a." means "not applicable" and is reserved for future use.																			
[Channel], [ECG], color temperature dimming	Warmer/colder	4 bit 3,007	KS																
This object is used to receive the telegrams for dimming the color temperature of the ECG of the channel.																			

07 B0 KNX / DALI Gateway Twin N 141/31 983D11
 07 B0 KNX / DALI Gateway Twin plus N 141/21 983411
 07 B0 KNX / DALI Gateway plus N 141/03 983711

Object name	Function	Type	Flag
[Channel], [ECG], color temperature value	16-bit value	2 byte 7.006	KS
This object is used to receive a color temperature value of the ECG of the channel.			
[Channel], [ECG], status color temperature	16-bit value	2 byte 7.006	KLÜ
This object acts as the sending object for the current status (color temperature value) of the ECG of channels. The current status is sent after starting a dimming process. Each further color temperature status telegram is sent after the "transmission period after state change" has elapsed. If the current value has not been sent when the dimming process has ended, this is sent immediately.			

10.7 Status/failure messages

General	
Status messages	
Parameters	Settings
ECG, status switching	No Send only on read request Send on status change Send on status change/bus voltage recovery
This parameter sets whether a switching status communication object should be added for each ECG and when these objects should be sent. Sending is not automatic if the setting is "send only on read request". Sending of the status on a read request is possible with any parameter setting except the parameter "not available". "Send on status change" sends the current status independently via the communication object after a change. The status is not sent automatically when the bus voltage is restored, even if it is changed in accordance with the setting. The setting "Send on status change/bus voltage recovery" automatically sends the current status after a change, as well as independently upon the bus voltage recovery.	
ECG, status dimming value	No Send only on read request Send on status change Send on status change/bus voltage recovery
This parameter sets whether a "status dimming value" communication object should be added for each ECG and when these objects should be sent. Sending is not automatic if the setting is "send only on read request". Sending of the status on a read request is possible with any parameter setting except the parameter "not available". "Send on status change" sends the current dimming value status for its change independently via the communication object. The dimming value is not sent automatically when the bus voltage returns, even if it is changed in accordance with the setting. The "send on status change/bus voltage recovery" setting sends the current dimming status for its change, as well as independently upon bus voltage recovery.	

07 BO KNX / DALI Gateway Twin N 141/31 983D11
 07 BO KNX / DALI Gateway Twin plus N 141/21 983411
 07 BO KNX / DALI Gateway plus N 141/03 983711

ECG, status color temperature	No Send only on read request Send status changes Send on status change/bus voltage recovery
<p>This parameter is used to set whether a "color temperature status" communication object should be added for each ECG and when these objects should be sent.</p> <p>Sending is not automatic if the parameter setting is "send only on read request." Sending of the status on a read request is possible with any parameter setting except the "not available" parameter.</p> <p>"Send on status change" sends the current color temperature value status independently via the communication object after a change. The color temperature value is not sent automatically when the bus voltage returns, even if it is changed in accordance with the setting.</p> <p>"Send on status change" sends the current color temperature value status independently via the communication object after a change.</p>	
[ECG], status failure	No Send only on read request Send on status change Send on status change/bus voltage recovery
<p>This parameter sets whether a "status failure" communication object should be added for each ECG, via which a light failure or a general failure in the ECG is to be reported and when these objects should be sent.</p> <p>Sending is not automatic if the setting is "send only on read request". Sending of the status on a read request is possible with any parameter setting except the parameter "not available".</p> <p>"Send on status change" sends the current status independently via the communication object after a change. The status is not sent automatically when the bus voltage is restored, even if it is changed in accordance with the setting.</p> <p>The setting "Send on status change/bus voltage recovery" automatically sends the current status after a change, as well as independently upon the bus voltage recovery.</p>	
ECG, Status failure code (1-byte)	No Send only on read request Send on status change Send on status change/bus voltage recovery
<p>This parameter is used to set whether per ECG a object "[Channel], [ECG], status error" to be supplemented for a lamp failure, ECG failure or inverter failure to report an ECG is and when these objects are to be sent.</p> <p>In the parameterization "Send only via read request" is no automatic send. The sending of the status of a read request is, with the exception of the parameter "not available", for each parameter setting possible.</p> <p>In the "Send on status change" is the current status in the change independently on the communication object is sent. If there is no bus voltage recovery automatic sending of status, even if it is in accordance with the parameterization changes. In the parameterization "send on status change / bus voltage recovery" to show the current status of the change and in addition for the bus voltage recovery independently sent.</p>	

07 BO KNX / DALI Gateway Twin N 141/31 983D11
 07 BO KNX / DALI Gateway Twin plus N 141/21 983411
 07 BO KNX / DALI Gateway plus N 141/03 983711

11. Sensors

The gateway supports selected sensors with the DALI interface, which are compatible to Siemens specification. They are used as additional devices on the DALI line. To do this, sensors can be added to each channel.

Both a tabular overview and a detailed presentation are available.

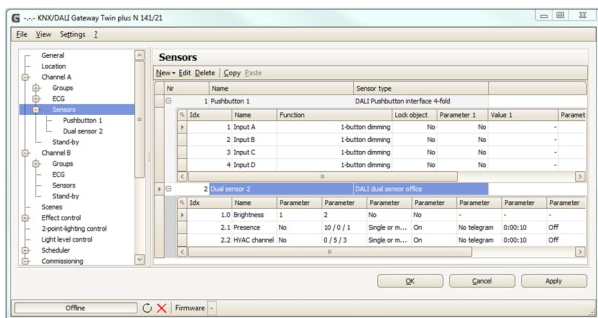

Fig. 15 Sensor parameters window

Parameters window menu	
New	A sensor is added from the selection list.
Edit	The parameters of a sensor can be edited in the detailed presentation.
Delete	The marked sensor(s) is/are deleted.
Copy	The marked sensor is copied to the clipboard
Paste	The sensor from the clipboard is added as a new sensor.

The different sensors are represented differently. The key parameters should be edited in the table. Consult "Quick-info" (mouse pointer points at the parameters) to view detailed information.

07 B0 KNX / DALI Gateway Twin N 141/31 983D11
 07 B0 KNX / DALI Gateway Twin plus N 141/21 983411
 07 B0 KNX / DALI Gateway plus N 141/03 983711

11.1 Overview

The gateway supports the following DALI ed. 1 sensors (currently only Siemens and OSRAM).

DALI push button input (max. 16 per channel)

Description	Order no.	Current consumption	Manufacturer
DALI 4x button input	5WG1141-2AB71	6 mA	Siemens
DALI PRO PB coupler	4008321496461	6 mA	OSRAM

DALI motion detector (max. 8 per channel)

Description	Order no.	Current consumption	Manufacturer
DALI LS/PD LI sensor coupler *	4052899043954	5 mA	OSRAM
DALI LS/PD CI *	4052899930292	5 mA	OSRAM
DALI sensor coupler E *	4052899230491	5 mA	OSRAM
DALI sensor LS/PD DALI LI UF *	4052899984608	5 mA	OSRAM
DALI Sensor Coupler HF *	4052899141728	2 mA	OSRAM
DALI HF LS LI sensor *	4052899921481		OSRAM
DALI HIGH BAY Adapter	4008321774132	5 mA	OSRAM
Sensors for HIGH BAY Adapter			
High-Bay PIR	4008321410078		OSRAM
Vision	4008321957047		OSRAM
DALI PRO sensor coupler	4008321379269	5 mA	OSRAM
Sensors for DALI sensor coupler			
Sensor Multi3 LS/PD for luminaire installation	4050300802138		OSRAM
Sensor Multi3 LS/PD FL for luminaire installation	4050300047342		OSRAM
Sensor Multi3 LS/PD B for luminaire installation	4050300803081		OSRAM
Sensor Multi3 LS/PD A for luminaire installation	4008321653604		OSRAM
Sensor Multi3 LS/PD for ceiling installation	4008321916648		OSRAM
DALI Presence detector (6 mA) *	- (no GTIN check)	6 mA	compatible to Siemens specification (currently only OSRAM)

07 B0 KNX / DALI Gateway Twin N 141/31 983D11
 07 B0 KNX / DALI Gateway Twin plus N 141/21 983411
 07 B0 KNX / DALI Gateway plus N 141/03 983711

The following DALI-2 sensors are supported** (currently only OSRAM):

DALI-2 presence detector (maximum 8 per channel)

Description	Order no.	Current consumption	Manufacturer
DALI COUPLER MULTI3 G2 25X1*	4062172072113	5mA	OSRAM
DALI SENSOR LS/PD LI G2 25X1*	4062172072069	5mA	OSRAM
DALI SENSOR LS/PD CI G2 10X1 *	4062172072083	5mA	OSRAM
D DALI COUPLER HF G2 25X1*	4062172072199	2mA	OSRAM
DALI COUPLER E G2 25X1*	4062172072212	2mA	OSRAM
DALI COUPLER LS HIGHBAY G2 20X1*	4062172072137	5mA	OSRAM
DALI SENSOR LS/PD LI UF G2 10X1 *	4062172072045	5mA	OSRAM

* usage not possible in pre-loaded applications

** these sensors can only be commissioned as "DALI Presence detector" (6 mA)

A possible time setting in the detector must be considered. If the used DALI motion or presence detector has a hardware-configurable delay, it needs to be set to a value lower than the delay value configured in the KNX/DALI gateway. Otherwise, the transmission to KNX of the motion detection will be not reliable.

The maximum number that can be added to each DALI channel is dependent on the total number of DALI devices on the channel and the total current drain permitted with this. The typical current consumption of DALI sensors can be found in the relevant product documentation.

www.siemens.com/gamma-td

www.osram.com

The Plugin calculates the current consumption of all configured DALI devices and limits to add devices, if the maximum is reached. If the maximum number of DALI devices is reached, you cannot add any more sensors or ECGs. The maximum guaranteed current is 190 mA per channel.

In case of „DALI Presence detector (6 mA)“ the use of a compatible DALI device to Siemens specification is expected with a current consumption of 6 mA. The functionality cannot be guaranteed, because there is no check of the GTIN (order no.) of DALI device.

07 B0 KNX / DALI Gateway Twin N 141/31 983D11
 07 B0 KNX / DALI Gateway Twin plus N 141/21 983411
 07 B0 KNX / DALI Gateway plus N 141/03 983711

11.2 DALI binary input

DALI binary input is a binary input device to be installed in an UP - socket. The device is powered via the connected DALI line. The device offers 4 input channels for potential-free contacts. Installation switches or installation keys can be connected. The necessary voltage is supplied by the DALI 4x key input (no additional voltage source required).

Triggered by the connected keys or switches, the DALI 4x binary input sends telegrams to the gateway via the DALI line. The 4 input channels function can be set on the corresponding parameters page.

One of the following features can be assigned to an individual input channel:

- Send status, binary value
- Switching edge
- 1-button dimming
- 1-button solar protection control
- 1-bit scene control
- 8-bit scene control
- 8-bit effect control
- 8-bit edge value

Two consecutive input channels (A + B or C + D), which have been configured as an input pair, can be assigned one of the following functions:

- 2-button dimming with stop telegram
- 2-button solar protection control
- 2-button dimming with stop telegram and double-click

This parameter is included once for two associated channels.

11.2.1 Parameters - General

The time behavior of the button function is the same for devices on both channels. Settings are entered in the General parameters window.

General	
Sensors	
Parameters	
	Settings
Long button press (dimming) [seconds]	0.3 to 10.0 0.5
This parameter sets the time duration that a button needs to be pressed for dimming.	
Long button press (blinds) from the [seconds]	0.3 to 10.0 0.5
This parameter sets the time duration that a button needs to be pressed for blind control.	
Long button press (scenes) from the [seconds]	0.3 to 10.0 5.0
This parameter sets the time duration that a button needs to be pressed for scene control.	

11.2.2 Parameters - Button input

Channel A (B)	
Sensors	
Parameter	
	Settings
No	
Sensor number	
Parameters	
Settings	
Name	
This parameter assigns each sensor a name with a maximum of 14 characters. This name is used for the communication objects belonging to this sensor.	
Sensor type	
Sensor product name	

07 BO KNX / DALI Gateway Twin N 141/31 983D11
 07 BO KNX / DALI Gateway Twin plus N 141/21 983411
 07 BO KNX / DALI Gateway plus N 141/03 983711

The parameter can be edited both in the tabular representation and in the detailed view.

In the table, the input channels can be extended by clicking on "+" in the "no." column or reduced by clicking on "-".

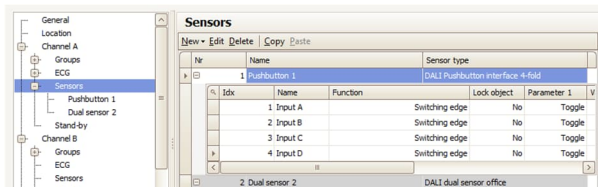

Fig. 16 Sensors button interface

In the detailed view, the parameters are stored in different registers.

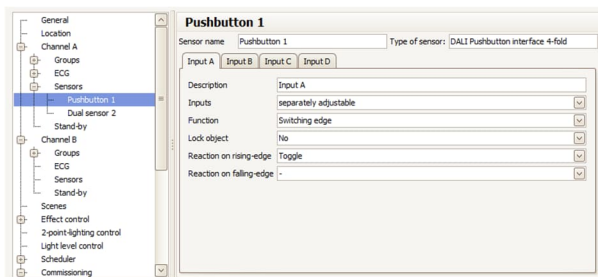

Fig. 17 Button interface – Details

11.3 Parameter - Input channels

Channel A (B)	
Sensors	
Parameters	Settings
Description	(max. 12 characters)
This parameter assigns a name to each input channel of the button interface. This name is also used for the communication objects.	
Inputs	Separately adjustable Collectively adjustable
This parameter sets whether each of the two inputs should be separately configurable or whether a joint 2-button function (dimming or solar protection) is assigned to both channels. Inputs, separately adjustable: Channels A and B can be configured separately. Inputs collectively adjustable: Only parameters in channel A can be changed. These settings define the behavior for channels A and B or channels C and D.	

07 B0 KNX / DALI Gateway Twin N 141/31 983D11
 07 B0 KNX / DALI Gateway Twin plus N 141/21 983411
 07 B0 KNX / DALI Gateway plus N 141/03 983711

11.3.1 Parameter - "Inputs, separately adjustable"

Channel A (B)	
Sensors	
Parameters	Settings
Function	Contact status, send binary value Switching edge 1-button dimming 1-button solar protection control 1-bit scene control 8-bit scene control 8-bit effect control 8-bit value edge
This parameter assigns the desired function to an input. Depending on the selected function, parameters faded in subsequently are changed.	
Lock object	No Yes
This parameter sets whether the input should be locked or not locked by an additional lock object. If the input is locked (lock object = 1), then status changes to this input are no longer analyzed. If, after unlocking the input, there is a status change compared with the status before locking, then the corresponding action is executed only for the set function "Contact status, send binary value". The status change is lost for all other possible functions. If the mains power supply is restored, the lock is disabled.	

11.3.1.1 Contact status, send binary value

This function is used, e.g. to query and transfer the switching status of a contact or of the voltage level present at the input. The parameter sets which binary value should be sent after a status change, whether the switching status/binary value should also be sent cyclically and whether the current switching status/binary value should also be sent automatically after the bus voltage or mains power is restored.

Channel A (B)	
Sensors	
Parameters	Settings
Switching value closed contact	On Off -
This parameter sets which switching value should be sent with a logical "1" at the input or after a leading edge of the input signal. The leading edge corresponds to a change of signal status at the input from logical "0" to logical "1". "-": An edge change at the input does not lead to a telegram being sent. "On": The switching value "ON" is sent in the case of a logical 1 at the input or a leading edge. "Off": The switching value "OFF" is sent in the case of a logical 1 at the input or with a leading edge.	
Switching value open contact	On Off -
This parameter sets which switching value should be sent with a logical "0" at the input or after a trailing edge of the input signal. The trailing edge corresponds to a change of signal status at the input from logical "1" to logical "0". "-": An edge change at the input does not lead to a telegram being sent. "On": The switching value "ON" is sent in the case of a logical 0 at the input or a trailing edge. "Off": The switching value "OFF" is sent in the case of a logical 0 at the input or a trailing edge.	

07 B0 KNX / DALI Gateway Twin N 141/31 983D11
 07 B0 KNX / DALI Gateway Twin plus N 141/21 983411
 07 B0 KNX / DALI Gateway plus N 141/03 983711

Send cyclically	No Always Send ON only Send OFF only
This parameter sets whether and when the switching value assigned to the contact status at the input should be cyclically sent.	
Cycle time in minutes (1..255)	1...255 5
This parameter is visible only if the previous parameter "Send cyclically" is not set to "No". This parameter sets the desired cycle time in minutes.	

Object name	Function	Type	Flag
[Channel], [Name], description, switching	on/off/ toggle	1 bit 1.001	CRWT
Example: A, button 1, input A, switch			
[Channel], [Name], description, lock	1 = lock	1 bit 1.001	CRWT
Example: A, button 1, input A, lock This object is only visible if "Locked object = Yes" is set as parameter.			

11.3.1.2 Switching edge

This function responds at inputs, to which a switch or a button is connected, to send a switching telegram (ON, OFF or TOGGLE) as response to a rising and/or falling signal edge at this input. By pressing and/or releasing the button, or closing and/or opening the switch, a telegram can be sent in each case, i.e. this function can replicate, for example, the behavior of a "bell push".

Channel A (B)	
Sensors	
Parameters	Settings
Reaction on rising-edge	On Off Toggle -
This parameter sets which switching value should be sent after a rising edge of the input signal. The leading edge corresponds to a change of signal status at the input from logical "0" to logical "1". "-": An edge change at the input does not lead to a telegram being sent. "On": The switching value "ON" is sent with a leading edge. "Off": The switching value "OFF" is sent with a leading edge. "Toggle": With a leading edge, the last switching value sent is inverted and the new value sent.	
Reaction on falling-edge	On Off Toggle -
This parameter sets which switching value should be sent after a falling edge of the input signal. The trailing edge corresponds to a change of signal status at the input from logical "1" to logical "0". "-": An edge change at the input does not lead to a telegram being sent. "On": The switching value "ON" is sent with a trailing edge. "Off": The switching value "OFF" is sent with a trailing edge. "Toggle": With a trailing edge, the last switching value sent is inverted and the new value sent.	

07 B0 KNX / DALI Gateway Twin N 141/31 983D11
 07 B0 KNX / DALI Gateway Twin plus N 141/21 983411
 07 B0 KNX / DALI Gateway plus N 141/03 983711

Object name	Function	Type	Flag
[Channel], [Name], description, switching	on/off/toggle	1 bit 1.001	CRWT
Example: A, button 1, input A, switch			
[Channel], [Name], description, lock	1 = lock	1 bit 1.001	CRWT
Example: A, button 1, input A, lock This object is only visible if "Locked object = Yes" is set as parameter.			

11.3.1.3 1-button dimming

This function enables a light/lighting group both to be switched on and off and dimmed brighter and darker with only a single button. For this, there is a distinction between tapping the button and holding it down.

- TOGGLE switch (tap button)

Tapping the button inverts the value that is in the switching object (TOGGLE switch) and then sends the ON or OFF telegram if the button is released (trailing edge).

- Dimming brighter/darker (button held down)

If the button is held down (the duration is variable, see 11.2.1), the light is dimmed brighter or darker, depending in the last activated dimming direction. If the dimming actuator is switched off, then holding down the button switches the light on and brightens it. If the actuator was previously switched on by tapping, then the light is dimmed when the button is first held down. If the dimming actuator is at a value from 1 to 99%, the last dimming direction operated is inverted and then dimmed in the new direction. If the button is held down, then the dimming object sends the command "Dim 100%" and when it is released (= trailing edge) it sends the "Stop" command.

Channel A (B)	
Sensors	
Parameter	Settings
Block Off	No Yes
This parameter suppresses the Off telegram from the binary output. The binary output can then send only Brighter/Darker and On telegrams.	

Object name	Function	Type	Flag
[Channel], [Name], description, switching	on/off/toggle	1 bit 1.001	CRWT
Example: A, button 1, input A, switch			
[Channel], [Name], description, dim	brighter/darker	4 bit 3.007	CRWT
Example: A, button 1, input A, dim			
[Channel], [Name], description, lock	1 = lock	1 bit 1.001	CRWT
Example: A, button 1, input A, lock This object is only visible if "Locked object = Yes" is set as parameter.			

07 B0 KNX / DALI Gateway Twin N 141/31 983D11
 07 B0 KNX / DALI Gateway Twin plus N 141/21 983411
 07 B0 KNX / DALI Gateway plus N 141/03 983711

11.3.1.4 1-button-solar protection control

This function drives a solar protection down and up, stops the travel and opens and closes slats with a single button only. For this, there is a distinction between tapping the button and holding it down.

- Solar protection up/down (button held down)

If the button is held down (the time period is variable, see 11.2.1), depending on the last direction of motion saved in the "Solar protection Up/Down" object, this inverts and moves the solar protection down or up until the respective end position is reached and the drive is switched off via the limit switch.

If a stop command is received before reaching an end position and the limit switch is touched, then movement is ended immediately, the position reached is held and the last direction of motion is saved.

- Stop or slats Open/Closed (tap button)

If the button is tapped, a telegram is sent that leads to the drive stopping in a solar protection movement and, if the solar protection is at rest, there is a short movement in the opposite direction to that preceding it (which is stored in the moving object). If the blind slats are closed, this would lead, say, to opening of the slats by one step. The STOP or slats OPEN or CLOSED telegram is only generated when the button is released (= trailing edge). Each additional tap sends another "Slats Open/Closed" telegram, in which the direction of motion is unchanged. The solar protection actuator software determines whether and how a number of consecutive "Slats Open/Closed" telegrams are interpreted and executed.

Object name	Function	Type	Flag
[Channel], [Name], description, solar protection	up/down	1 bit 1.008	CRWT
Example: A, button 1, input A, solar protection			
[Channel], [Name], description, slats	stop/open/close	1 bit 1.009	CRWT
Example: A, button 1, input A, slats			
[Channel], [Name], description, lock	1 = lock	1 bit 1.001	CRWT
Example: A, button 1, input A, lock			
This object is only visible if "Locked object = Yes" is set as parameter.			

07 B0 KNX / DALI Gateway Twin N 141/31 983D11
 07 B0 KNX / DALI Gateway Twin plus N 141/21 983411
 07 B0 KNX / DALI Gateway plus N 141/03 983711

11.3.1.5 1-bit scene control

With the "1-bit scene control" feature, the user can independently, without changing the scheduling with the ETS, reprogram a scene module for 1-bit scene control, i.e. assign different brightness values or switching states to the individual groups of the relevant scene. With a single button, you can recall a scene by tapping the button and save it by holding the button down, with a communication object serving to save a scene and a second to recall a saved scene. With this, you can set whether scene 1 is to be saved or recalled with a telegram with the value "0" and likewise with a telegram with the value "1" for scene 2.

Before saving a scene, the relevant actuators must be set to the wanted brightness values or switching states with the buttons/sensors provided for this purpose.

Receipt of a "Save" telegram prompts the contacted scene modules to query the currently set brightness values and states from the actuators integrated in the scene and save them in the relevant scene.

In order not to trigger a scene save by holding down the button inadvertently instead of tapping it, a scene save should be triggered only by holding down the button for an "extra-long" period.

Channel A (B)	
Sensors	
Parameters	Settings
Scene number	1 2
This parameter determines which scene should be saved or recalled. "1": Tapping the button sends a telegram with the value "0", in order that scene 1 is recalled by the contacted scene modules. Holding down the button prompts the contacted scene modules to query the currently set values and states in the actuators integrated in the scene and to save the scene numbered 1. "2": This setting saves and restores scene 2.	
Scene program	Yes No
This parameter sets whether the set scene can not only be called up, but whether it must also be saved.	

Object name	Function	Type	Flag
[Channel], [Name], description, scenes 1/2	Recall	1 bit 1.022	CRWT
Example: A, button 1, input A, scenes 1/2			
[Channel], [Name], [description], scenes 1/2	save	1 bit 1.022	CRWT
Example: A, button 1, input A, scenes 1/2 This object is only visible if "Save scene = Yes" is set as parameter.			
[Channel], [Name], description, lock	1 = lock	1 bit 1.001	CRWT
Example: A, button 1, input A, lock This object is only visible if "Locked object = Yes" is set as parameter.			

07 B0 KNX / DALI Gateway Twin N 141/31 983D11
 07 B0 KNX / DALI Gateway Twin plus N 141/21 983411
 07 B0 KNX / DALI Gateway plus N 141/03 983711

11.3.1.6 8-bit scene control

The "8-bit scene control" function enables the user to call up 8-bit scenes and, without changing the scheduling with the ETS, reprogram scene modules for 8-bit scene control or actuators with integrated 8-bit scene control personally (i.e. assign current values or states to the relevant scene).

Tapping a key recalls the scene with the set number (1...64) and holding it down saves it, with which, via single communication object, both the command to save a scene and the command to recall a saved scene and the number of the desired scene are transferred.

Before saving a scene, the actuators integrated in the scene must be set to the desired values or states with the buttons/sensors provided for this purpose. Receipt of a telegram prompts the contacted scene modules to query the currently set values and states from the actuators integrated in the scene and save them in the relevant scene.

You can set whether the button should be used only to recall a scene (telegrams for saving a scene will not be sent) or whether it can also trigger saving of a scene. In order not to trigger a scene save by holding down the button inadvertently instead of tapping it, a scene save should be triggered only by holding down the button for an "extra-long" period.

Channel A (B)	
Sensors	
Parameters	Settings
Scene number	1-64 1
This parameter determines which scene should be saved or recalled.	
Scene program	Yes No
This parameter sets whether the set scene can not only be called up, but whether it must also be saved.	

Object name	Function	Type	Flag
[Channel], [Name], description, 8-bit scene	recall/save	1 byte 18.001	CRWT
Example: A, button 1, input A, 8-bit scene			
[Channel], [Name], description, lock	1 = lock	1 bit 1.001	CRWT
Example: A, button 1, input A, lock This object is only visible if "Locked object = Yes" is set as parameter.			

07 B0 KNX / DALI Gateway Twin N 141/31 983D11 07 B0 KNX / DALI Gateway Twin plus N 141/21 983411 07 B0 KNX / DALI Gateway plus N 141/03 983711
--

11.3.1.7 8-bit effect control

The "8-bit effect control" function enables an effect with the set number (1..64) to be started and stopped with a button connected to the I/O button interface in a KNX/DALI gateway. As with scene control, there is a distinction between tapping the button and holding it down in this case.

Channel A (B)	
Sensors	
Parameter	Settings
Effect number	1-64 1
This parameter determines which effect should be started or stopped.	

Object name	Function	Type	Flag
[Channel], [Name], description, 8-bit effect	start/stop	1 byte 18.001	CRWT
Example: A, button 1, input A, 8-bit effect			
[Channel], [Name], description, lock	1 = lock	1 bit 1.001	CRWT
Example: A, button 1, input A, lock This object is only visible if "Locked object = Yes" is set as parameter.			

11.3.1.8 8-bit value edge

This function sends 8-bit integer values (DPT 5.005/EIS 6) in the range from 0..255. You can set whether a value telegram is sent either as the response to a leading and/or a trailing signal edge at the input (e.g. when pressing and/or releasing a button). For example, this function assigns a dimming value to a button, in order to dim the corresponding lights to the set value in this way, or a number of buttons are assigned different values with this button.

Channel A (B)	
Sensors	
Parameters	Settings
Send value rising-edge	Yes No
This sets whether the configured 8-bit value should be written into the memory cell of the communication object and sent, after a leading edge of the signal state at the input, or not. The leading edge corresponds to a change of signal status at the input from logical "0" to logical "1".	
Value rising-edge	0..255 0
This sets which value (0..255) is written into the memory cell of the communication object after a leading edge, and sent. The leading edge corresponds to a change of signal status at the input from logical "0" to logical "1".	
Send value falling-edge	Yes No
This sets whether the configured 8-bit value should be written into the memory cell of the communication object and sent, after a falling edge of the signal state at the input, or not. The trailing edge corresponds to a change of signal status at the input from logical "1" to logical "0".	
Value falling-edge	0..255 0
This sets which value (0..255) is written into the memory cell of the communication object after a trailing edge, and sent. The trailing edge corresponds to a change of signal status at the input from logical "1" to logical "0".	

Object name	Function	Type	Flag
[Channel], [Name], description, 8-bit value	send value	1 byte 5.007	CRWT
Example: A, button 1, input A, 8-bit value			

07 B0 KNX / DALI Gateway Twin N 141/31 983D11
 07 B0 KNX / DALI Gateway Twin plus N 141/21 983411
 07 B0 KNX / DALI Gateway plus N 141/03 983711

Object name	Function	Type	Flag
[Channel], [Name], description, lock	1 = lock	1 bit 1.001	CRWT
Example: A, button 1, input A, lock This object is only visible if "Locked object = Yes" is set as parameter.			

11.3.2 Parameter - "Inputs together adjustable"

Channel A (B)	
Sensors	
Parameters	Settings
Function	2-button dimming with stop telegram; 2-button solar protection control 2-button dimming with stop telegram and double-click
This parameter is visible if a joint 2-button function should be assigned to an input pair. Depending on the selected function, parameters faded in subsequently are changed.	
Lock object	No Yes
This parameter sets whether the input should be locked or not locked by an additional lock object. If the input is locked (lock object = 1), then status changes to this input are no longer analyzed. If, after unlocking the input, there is a status change compared with the status before locking, then the set function corresponding to this is executed. If the mains power supply is restored, the lock is disabled.	

07 B0 KNX / DALI Gateway Twin N 141/31 983D11
 07 B0 KNX / DALI Gateway Twin plus N 141/21 983411
 07 B0 KNX / DALI Gateway plus N 141/03 983711

11.3.2.1 2-button dimming with stop telegram

Tapping the button pair connected to both inputs switches the lighting on or off and holding it down dims or brightens it. You can set which button (or which input) is to be used for switching off and darkening or switching on and brightening.

When "2-button dimming with Stop telegram" is set, as soon as a button being held down is detected, a "100% brighter" or "100% darker" dimming telegram is sent and on releasing the button a stop telegram is sent.

Channel A (B)	
Sensors	
Parameter	Settings
Function per input	Off, darker/on, brighter On, brighter/off, darker Toggle, darker/toggle, brighter Toggle, brighter/toggle, darker
This parameter sets which telegram is sent when the relevant button is tapped or held down.	

Object name	Function	Type	Flag
[Channel], [Name], description, switching	on/off/toggle	1 bit 1.001	CRWT
Example: A, button 1, input A, switch			
[Channel], [Name], description, dim	brighter/darker	4 bit 3.007	CRWT
Example: A, button 1, input A, dim			
[Channel], [Name], description, lock	1 = lock	1 bit	CRWT
Example: A, button 1, input A, lock			
This object is only visible if "Locked object = Yes" is set as parameter.			

07 B0 KNX / DALI Gateway Twin N 141/31 983D11
 07 B0 KNX / DALI Gateway Twin plus N 141/21 983411
 07 B0 KNX / DALI Gateway plus N 141/03 983711

11.3.2.2 2-button-solar protection control

Hold down a pair of buttons to lower or raise the solar protection to the relevant stop position and tap a button to end the travel or move the slats by a single step. You can set with which button (or with which input) solar protection is lowered and the slats closed by one step if necessary or solar protection is raised and the slats opened by one step if necessary.

Channel A (B)	
Sensors	
Parameter	Settings
Function per input	Blinds down, slats closed/blinds up, slats open Blinds up, slats open/blinds down, slats closed
This parameter sets which bus telegram is sent when the relevant button is tapped or held down.	

Object name	Function	Type	Flag
[Channel], [Name], description, solar protection	up/down	1 bit 1.008	CRWT
Example: A, button 1, input A, solar protection			
[Channel], [Name], description, slats	stop/open/close	1 bit 1.009	CRWT
Example: A, button 1, input A, slats			
[Channel], [Name], description, lock	1 = lock	1 bit 1.001	CRWT
Example: A, button 1, input A, lock			
This object is only visible if "Locked object = Yes" is set as parameter.			

07 BO KNX / DALI Gateway Twin N 141/31 983D11
 07 BO KNX / DALI Gateway Twin plus N 141/21 983411
 07 BO KNX / DALI Gateway plus N 141/03 983711

11.3.2.3 2-button dimming with stop telegram and double-click

Tapping the button pair connected to both inputs switches the lighting on or off and holding it down dims or brightens it. You can set which button (or which input) is to be used for switching off and darkening or switching on and brightening.

When "2-button dimming with Stop telegram and double-click" is set, as soon as a button being held down is detected, a "100% brighter" or "100% darker" dimming telegram is sent and on releasing the button a stop telegram is sent.

If the "double-click" (quick double pressing) is executed for an input, then it is sent by the 1-bit "Trigger" object.

Channel A (B)	
Sensors	
Parameter	Settings
Function per input	Off, darker/on, brighter On, brighter/off, darker Toggle, darker/toggle, brighter Toggle, brighter/toggle, darker
This parameter sets which telegram is sent when the relevant button is tapped or held down.	

Object name	Function	Type	Flag
[Channel], [Name], description, switching	on/off/toggle	1 bit 1.001	CRWT
Example: A, button 1, input A, switch			
[Channel], [Name], description, dim	brighter/darker	4 bit 3.007	CRWT
Example: A, button 1, input A, dim			
[Channel], [Name], [Description], trigger	On	1 bit 1.001	CRWT
Example: A, button 1, input A, Trigger "1" is sent by this object if a double-click is made at the input. This command, for example, can save the current brightness value as a target value for constant light control.			
[Channel], [Name], description, lock	1 = lock	1 bit 1.001	CRWT
Example: A, button 1, input A, lock This object is only visible if "Locked object = Yes" is set as parameter.			

07 BO KNX / DALI Gateway Twin N 141/31 983D11
 07 BO KNX / DALI Gateway Twin plus N 141/21 983411
 07 BO KNX / DALI Gateway plus N 141/03 983711

11.4 DALI Presence detector

The DALI motion detector is independently powered by the connected DALI line. The sensor includes a sensor head with a connection lead and a controller. In the sensor head are housed a brightness sensor, a presence detector (PIR) and a green LED (flashes while recording motion). The coupling to the DALI line is implemented in the controller. Brightness or a presence detector event is transferred via the DALI line to a DALI controller or gateway.

11.4.1 Sensor channel - presence

The DALI office combo-sensor has only one physical presence sensor. However, the presence detection signal is output via two independent channels, each with a parameter block. This enables a different analysis for detection for, say, lighting and HLK (heating, ventilation and air conditioning) control, for which the standard values for this example are preconfigured.

11.4.1.1 General

The standard parameters are highlighted in **BOLD** type below: **Presence (HLK detector)**.

Channel A (B)	
Sensors	
Parameters	Settings
Lock via object	No Yes, if lock object = 0 Yes, if lock object = 1
This parameter sets how the value of the lock object is analyzed.	
Lock object at voltage recovery	Off On Like before voltage failure Read from bus
This parameter is visible only if the previous parameter "Lock via object" is not set to "No". This parameter determines with which value the object "Motion detector locking" is pre-populated. The behavior applies both for mains and for bus voltage recovery.	
Motion detection up to brightness [Lux] (0 = brightness independent):	0-1000 10 (0)
This parameter controls the reporting of a motion dependent on the ambient brightness. If a motion was detected previously (delay time running), then the ambient brightness is no longer analyzed. In other words, if further movements occur during a detected movement, then the delay time is restarted. The brightness value is received via the object "Brightness - Actual value".	
Interval for presence detection [min]	0-15 0 (5)
This parameter determines the time interval in which the movement pulse is counted .(0 = disabled)	
Minimum amount of motions during interval time:	1-50 1 (3)
This parameter determines the number of movements that must be detected during the monitoring period to meet the criterion for beginning HLK presence. This ensures that a HLK presence then begins only if people have stayed within detection range of the sensor over a protracted period.	
Device mode	Subgroup Individual or master device
This parameter determines whether the sensor is used as an individual device or master or as an ancillary device (slave) in conjunction with other motion detectors.	

07 B0 KNX / DALI Gateway Twin N 141/31 983D11
 07 B0 KNX / DALI Gateway Twin plus N 141/21 983411
 07 B0 KNX / DALI Gateway plus N 141/03 983711

Channel A (B)	
Sensors	
Parameters	Settings
Down time after end of detection (0 ... 59 seconds)	0...59 5
<p>The dead time avoids a fast switch-on or switch-off of the lights. This effect generally occurs if the lights (heat source) are in the detection area. If a movement occurs in the dead period, then the motion detector does not switch on. Note 1: The dead time should be chosen so that it is longer than the delay time between telegrams (C) and (D), because otherwise telegram (D) can sometimes fail. Note 2: As the sensor is "active" internally for approximately 3 seconds (TBC) after detecting a movement, it may be that a movement detected during a dead time triggers a telegram. This is the case if movement is detected within the last 3 seconds of dead time. To guarantee that the dead time is also effective, this should be chosen to be as long as possible.</p>	
The dead time also affects Extension line	No Yes
<p>If the system is configured so that the dead time also acts on the extension unit (Yes), then the extension unit "buffers" a trigger in the detector and only sends the corresponding telegrams (A) to (D) after the dead time has elapsed. If the parameter is set to "No", the extension unit triggers act immediately.</p>	

11.4.1.2 Device mode - Single device or master

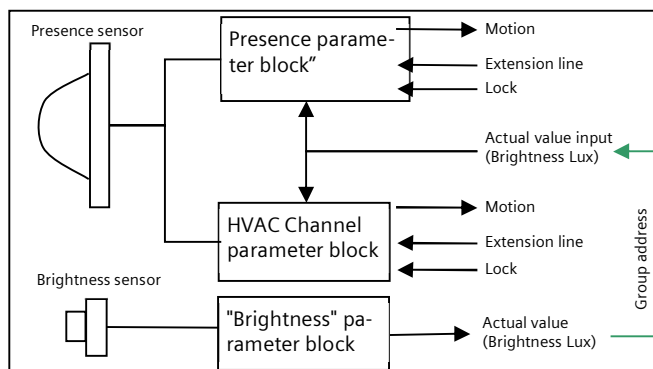

Fig. 18 Function blocks

Each presence channel can send up to 4 telegrams:

- Begin (A) movement
- End (C) movement

and in each case delayed

- Begin (B) movement
- End (D) movement

If the sensor detects a movement, the telegram "Begin (A) movement" is sent immediately. If the system has also been configured to send a "second telegram B", the "Begin (B) movement" telegram is also sent after the set time (sometimes cyclically also).

If movements are no longer taking place, then at the end of the delay time the telegram "End (C) movement" and (if configured) the telegram "End (D) movement" are sent. The telegram (D) can also be sent cyclically. If further movements occur while the delay time is still running, then the delay time is restarted.

07 B0 KNX / DALI Gateway Twin N 141/31 983D11
07 B0 KNX / DALI Gateway Twin plus N 141/21 983411
07 B0 KNX / DALI Gateway plus N 141/03 983711

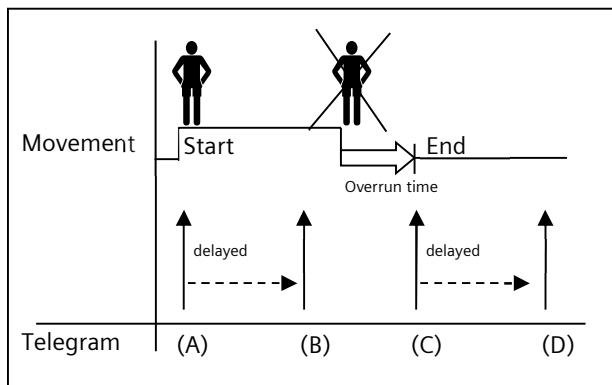

Fig. 19 Presence detector telegram sequence

11.4.1.2.1 Begin movement

Channel A (B)	
Sensors	
Parameters	Settings
In case of detection, send telegram (A)	No telegram On Off 8-bit value Scene 16-bit-value (decimal) 16-bit value (temperature) 16-bit value (brightness)
This parameter determines whether a telegram is sent after movement is detected and, if applicable, which format the telegram has.	
Value (0...255)	0...255 0
Scene number	1...64 1
Value (0...65535)	0..65535 0
Value [°C]	0...40 16.5
Value [Lux]	0...2000 500
Second telegram (B)	No telegram On Off 8-bit value Scene 16-bit-value (decimal) 16-bit value (temperature) 16-bit value (brightness)
This parameter sets whether, after a detected movement, a further telegram is sent if necessary and what type of telegram should be sent.	

07 B0 KNX / DALI Gateway Twin N 141/31 983D11
 07 B0 KNX / DALI Gateway Twin plus N 141/21 983411
 07 B0 KNX / DALI Gateway plus N 141/03 983711

Delay of second telegram (B) (0...255 sec)	0...255 0
This parameter is visible only if the previous parameter "Send second telegram (B)" was not set to "No telegram". This determines with what interval from the first telegram (A) the second telegram (B) is sent.	
Value (0...255)	0...255 0
Scene number	1...64 1
Value (0...65535)	0..65535 0
Value [°C]	0...40 16.5
Value [Lux]	0...2000 500
Cyclically send second telegram (B) [s] (0 = no cyclic sending)	0 - 255 0
If cyclic sending is desired after motion is detected, then this parameter should be set to the corresponding value.	

11.4.1.2.2 Delay Time

Channel A (B)	
Sensors	
Parameters	Settings
Time	1 2
This parameter determines whether the delay time is always the same ("1 = a delay time") or can be changed via a "Delay time" object. If "2 = two delay times" is set, then delay time 1 or delay time 2 can be selected via the telegram.	
Delay time 1 [h:mm:ss]	0:00:00-1:55:59 00:00:10
This parameter determines the minimum time for a detected movement. At the end of the delay time, an End (C) movement and optionally an End (D) movement telegram are sent. If a movement had been detected previously (delay time running) and no further movements occur, the delay time is restarted.	
Delay time 2 [h:mm:ss]	0:00:00-1:55:59 00:00:10
If the "Time" parameter is set to "2" (two delay times), then this parameter is available.	

07 B0 KNX / DALI Gateway Twin N 141/31 983D11
 07 B0 KNX / DALI Gateway Twin plus N 141/21 983411
 07 B0 KNX / DALI Gateway plus N 141/03 983711

11.4.1.2.3 End of movement

Channel A (B)	
Sensors	
Parameters	Settings
In case of no detection, send telegram (C)	No telegram On Off 8-bit value Scene 16-bit-value (decimal) 16-bit value (temperature) 16-bit value (brightness)
This parameter determines whether a telegram is sent after movement is detected and which format the telegram has.	
Value (0...255)	0...255 0
Scene number	1...64 1
Value (0...65535)	0..65535 0
Value [°C]	0...40 16.5
Value [Lux]	0...2000 500
Second telegram (D)	No telegram On Off 8-bit value Scene 16-bit-value (decimal) 16-bit value (temperature) 16-bit value (brightness)
This parameter sets whether, after end of movement is detected, a further telegram should be sent if necessary and what type of telegram should be sent.	
Delay for second telegram (D) (0...255 sec)	0...255 0
This parameter is visible only if the previous parameter "Send second telegram (D)" was not set to "No telegram". This determines with what interval from the first telegram (C) the second telegram (D) is sent.	
Value (0...255)	0...255 0
Scene number	1...64 1
Value (0...65535)	0..65535 0
Value[°C]	0...40 16.5
Value [Lux]	0...2000 500
Send second telegram (D) cyclically [s] (0 = no cyclic sending)	0 - 255 5
If cyclic sending is desired after motion is detected, then this parameter should be set to the corresponding value.	

07 B0 KNX / DALI Gateway Twin N 141/31 983D11
 07 B0 KNX / DALI Gateway Twin plus N 141/21 983411
 07 B0 KNX / DALI Gateway plus N 141/03 983711

Telegrams (C) [and (D)] Send after voltage is restored	No Yes
This parameter determines whether, after voltage recovery, telegrams C and D (if configured) are sent automatically. The behavior applies both for mains and for bus voltage recovery.	

Object name	Function	Type	Flag
[Channel], [Name], description, motion (A) start	On/Off	1 bit 1.001	CRWT
	Scene	1 byte 17.001	
	8-bit value	1 byte 5.001	
	16-bit value	2 byte 7.001	
	16-bit value (°C)	2 byte 9.001	
	16-bit value (Lux)	2 byte 9.004	
Depending on the configuration, this object sends one of the following values to the bus at the start of a detected movement or on external triggering ("Extension unit on" object): <ul style="list-style-type: none"> • Switch On/Off • Call up 8-bit scenes • 8-bit-value (decimal) (0 – 255) • 16-bit value (decimal) (0 - 65 535) • 16-bit value (temperature) (0°C – 40 °C) • 16-bit value (brightness) (0 – 2000 Lux) 			
[Channel], [Name], description, motion (B) start	On/Off	1 bit 1.001	CRWT
	Scene	1 byte 17.001	
	8-bit value	1 byte 5.001	
	16-bit value	2 byte 7.001	
	16-bit value (°C)	2 byte 9.001	
	16-bit value (Lux)	2 byte 9.004	
Depending on the configuration (delay), this object sends one of the following values to the bus at the start of a detected movement or on external triggering ("Extension unit on" object): <ul style="list-style-type: none"> • Switch On/Off • Call up 8-bit scenes • 8-bit-value (decimal) (0 – 255) • 16-bit value (decimal) (0 - 65 535) • 16-bit value (temperature) (0°C – 40 °C) • 16-bit value (brightness) (0 – 2000 Lux) The "Begin (B) movement" is sent after telegram A, if it has been configured. The delay time between A and B is also configurable.			

07 B0 KNX / DALI Gateway Twin N 141/31 983D11
 07 B0 KNX / DALI Gateway Twin plus N 141/21 983411
 07 B0 KNX / DALI Gateway plus N 141/03 983711

[Channel], [Name], description, motion (C) end	On/Off	1 bit 1.001	CRWT
	Scene	1 byte 17.001	
	8-bit value	1 byte 5.001	
	16-bit value	2 byte 7.001	
	16-bit value (°C)	2 byte 9.001	
	16-bit value (Lux)	2 byte 9.004	

Depending on the configuration, this object sends one of the following values to the bus at the end of a detected movement or on external triggering ("Extension unit off" object) and elapsing of the delay time:

- Switch On/Off
- Call up 8-bit scenes
- 8-bit-value (decimal) (0 – 255)
- 16-bit value (decimal) (0 - 65 535)
- 16-bit value (temperature) (0°C – 40 °C)
- 16-bit value (brightness) (0 – 2000 Lux)

[Channel], [Name], description, motion (D) end	On/Off	1 bit 1.001	CRWT
	Scene	1 byte 17.001	
	8-bit value	1 byte 5.001	
	16-bit value	2 byte 7.001	
	16-bit value (°C)	2 byte 9.001	
	16-bit value (Lux)	2 byte 9.004	

Depending on the configuration, this object sends one of the following values to the bus at the end of a detected movement or on external triggering ("Extension unit off" object) and elapsing of the delay time:

- Switch On/Off
- Call up 8-bit scenes
- 8-bit-value (decimal) (0 – 255)
- 16-bit value (decimal) (0 - 65 535)
- 16-bit value (temperature) (0°C – 40 °C)
- 16-bit value (brightness) (0 – 2000 Lux)

The "End (D) movement" is sent after telegram C, if it has been configured. The delay time between C and D is also configurable.

07 B0 KNX / DALI Gateway Twin N 141/31 983D11
 07 B0 KNX / DALI Gateway Twin plus N 141/21 983411
 07 B0 KNX / DALI Gateway plus N 141/03 983711

[Channel], [Name], description, delay time	0 = time 1/ 1 = time 2	1 bit 1.003	CRWT
This object is only visible with the setting Time = 2. This object impacts the detector delay time. It selects one of the two previously set delay times. This object is backed up on bus and mains supply failure and restored on bus and mains supply recovery.			
[Channel], [Name], description, lock	On/Off	1 bit 1.001	CRWT
This object locks the detector and releases it again. The parameter "Lock via object" varies whether the detector is locked with a received "0" or a received "1". You can also set it such that the detector, regardless of the above object, is never locked. A locked detector does not analyze detected movements. <u>Note:</u> Movement reports covering extension unit movement are also observed with the movement detector locked. The start value after power supply recovery is configurable.			
[Channel], [Name], [Description], extension unit	Motion on	1 bit 1.017	CRWT
This object triggers the detector externally. In other words, as soon as the detector receives the value "1" via this object, telegrams (A) and (B) are sent regardless of the configuration.			
[Channel], [Name], [Description], extension unit	Motion off	1 bit 1.017	CRWT
This object switches the detector off in a defined manner. In other words, as soon as the detector receives the value "0" via this object, the delay time is ended and telegrams (C) and (D) are sent regardless of the configuration.			
[Channel], [Name], brightness, actual value	Brightness (Lux)	2 byte 9.004	CRT
Sent via this object cyclically its brightness value. Is the cyclic send off, the value with a read request via the bus.			

07 BO KNX / DALI Gateway Twin N 141/31 983D11
 07 BO KNX / DALI Gateway Twin plus N 141/21 983411
 07 BO KNX / DALI Gateway plus N 141/03 983711

11.4.1.3 Device mode – Slave

In the "Slave" device mode, the detection area of the presence detector can be enlarged. The "Slave" reports to the "Master" via a "Trigger" object a movement detected in the capture area via the "Trigger" object. All other settings for delay time, telegram types, etc. are configured in the "Master".

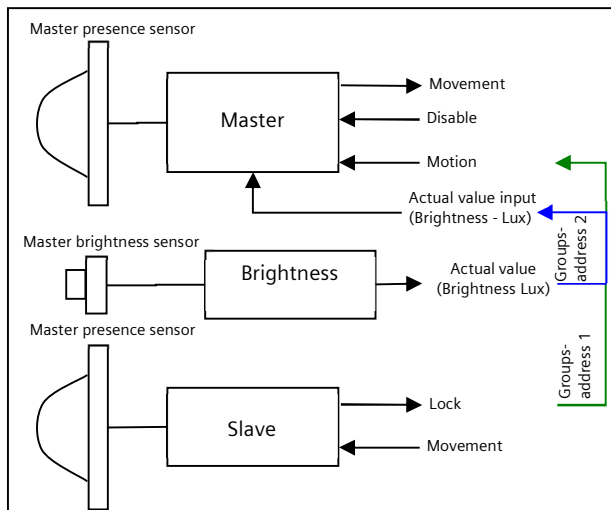

Fig. 20 Master/Slave function blocks

Channel A (B)	
Sensors	
Parameter	Settings
Cyclically send trigger telegram [s] (0 = no cyclic sending)	0 - 255 5
In "Slave" device mode, only an "On telegram" can be sent to the "Master", if motion has been detected, in order to trigger this through the extension unit input. The internal delay time of 10 seconds is set firmly, in other words a telegram can be sent to the master every 10 seconds at most. If a permanent triggering of the extension detector (Slave) occurs, then a telegram is sent to the master only with the first triggering. In this case, however, if the user wants to send further telegrams, then this is achievable while the above parameter is set accordingly.	

Object name	Function	Type	Flag
[Channel], [Name], [Description], trigger	On	1 bit 1.017	CRWT
This object sends an "On telegram" on detection.			

07 BO KNX / DALI Gateway Twin N 141/31 983D11
 07 BO KNX / DALI Gateway Twin plus N 141/21 983411
 07 BO KNX / DALI Gateway plus N 141/03 983711

11.4.2 Sensor channel - Brightness

An object sends the measured brightness value of the integrated brightness sensor. The measured value can be adjusted to the ambient conditions by using a correction factor. The correction factor can be calculated during commissioning (→ Section 21.1.6).

Parameters	Settings
Adjustment factor	0.1-20.0 1.0
The light measured by the light sensor is multiplied by the correction factor. The correction factor can also only be determined during commissioning (→ Section 21.1.6).	
Average value	1-4 2
For brightness measurement, the average value can be formed from a number of values measured consecutively. This parameter determines the number of values to be used for forming the average value.	
Send brightness value cyclic	Yes No
Determines whether the object sends the brightness value cyclically.	
Send brightness value cyclic [mm:ss]	00:01 - 59:59 01:00
This parameter determines the intervals at which the calculated brightness value is sent via the bus	
Send brightness value on change	Yes No
Determines whether the brightness value should be sent if the absolute and relative deviations are exceeded. If a brightness value is sent as a result if the change, the timer is restarted for cyclic sending.	
Absolute difference [Lux]	1-1000 50
Relative difference [%]	1-100 10

Note: Brightness values are updated via DALI at intervals of up to eight (8) seconds.

Object name	Function	Type	Flag
[Channel], [Name], [Description], actual value input	Brightness (Lux)	2 byte 9.004	CRT
On this object receives the motion detector the brightness value for the brightness-dependent motion detection.			

07 B0 KNX / DALI Gateway Twin N 141/31 983D11
 07 B0 KNX / DALI Gateway Twin plus N 141/21 983411
 07 B0 KNX / DALI Gateway plus N 141/03 983711

12. Stand-by

The "Stand-by" function makes it possible to deactivate the power supply of the ECGs if they are shut off (brightness value =0). Groups or ECGs can be assigned to one of 6 areas per channel. If all of the assigned Groups and ECGs have the brightness value 0 (off), then it is sent by a communication object [Channel], Stand-by, [Name] 0 (Off). The command can be correspondingly delayed with the "Off after" parameter.

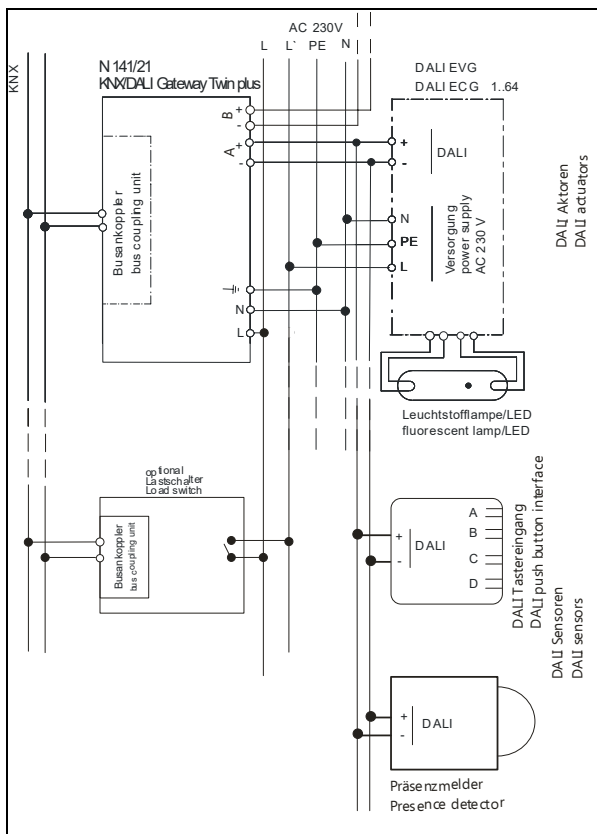

Fig. 21 Connection example for stand-by shut-off with load switches.

The shut-off command is suitable for using a load switch to disconnect the power supply of the corresponding ECGs and to thus deactivate the ECG's available standby current. (→Fig. 20).

Stand-by						
Name	Off after [mm:ss]	Delay on (DALI) [s]	A,G1: Group 1	A,G2: Group 2	A,G3: Group 3	
Area 1	00:00	0.7	<input type="radio"/>	<input type="radio"/>	<input type="radio"/>	
Area 2	00:00	0.7	<input type="radio"/>	<input type="radio"/>	<input type="radio"/>	
Area 3	00:00	0.7	<input type="radio"/>	<input type="radio"/>	<input checked="" type="radio"/>	
Area 4	00:00	0.7	<input type="radio"/>	<input type="radio"/>	<input type="radio"/>	
Area 5	00:00	0.7	<input type="radio"/>	<input type="radio"/>	<input type="radio"/>	
Area 6	00:00	0.7	<input checked="" type="radio"/>	<input checked="" type="radio"/>	<input checked="" type="radio"/>	

Fig. 22 Standby parameters window

07 B0 KNX / DALI Gateway Twin N 141/31 983D11
 07 B0 KNX / DALI Gateway Twin plus N 141/21 983411
 07 B0 KNX / DALI Gateway plus N 141/03 983711

Parameters window menu	
New	A new area is added.
Delete	The marked area is deleted.
Copy	The marked area is copied to the clipboard
Paste	The area from the clipboard is added as a new area.

Channel A (B)	
Stand-by	
Parameters	Settings
Name (25 characters)	
This parameter can be used to assign an area a name with a maximum of 25 characters. This name is used for the communication objects belonging to this area.	
Delay after [mm:ss]	0:00...59:59 00:00
This is permanently used to deactivate the delay between all assigned ECGs (brightness value = 0) and the sending of an off-telegram by the associated communication object.	
Delay ON (DALI) [s]	0.5...25.5 0.7
This parameter is used to define and set the delay between one or more assigned ECGs (brightness value > 0) and the sending of the DALI commands. In this process, the delay must not be shorter than the start time (ramp-up time) of the ECG. The delay is not considered for dimming ramps (or time functions).	

The stand-by function provides the following communication object for each area:

Object name	Function	Type	Flag
[Channel], Stand-by, [Name]	On/Off	1 bit DPT 1.001	CRT
This object is used to trigger a load switch relay, which shuts off the mains power supply of the ECGs of a defined deactivation area as soon as the last group or last ECG of the deactivation area has been shut off by DALI (dimming value = 0). When an ECG or a group is switched on, this object returns to On and switches the mains power supply of the ECGs back on.			

Note:

Assigned ECGs with device type 1 (Emergency lighting with single battery) are not considered.

No failures (ECG / lamp failures) are detected in this area when its deactivation is active.

All regions are switched on in direct mode / configuration.

07 B0 KNX / DALI Gateway Twin N 141/31 983D11
 07 B0 KNX / DALI Gateway Twin plus N 141/21 983411
 07 B0 KNX / DALI Gateway plus N 141/03 983711

13. Scenes

The application program enables up to 32 scenes to be configured.

If every scene receives ECGs from both channels, a total of 16 scenes can be configured in this way. If every scene contains only ECGs from a channel, 16 scenes can be configured for each channel, i.e. a total of 32 scenes for two channels. The number of scenes used is shown in the status line. If the maximum number is reached, a failure message is generated.

All scenes are represented line by line in the Scenes parameter window. All available groups from channels A and B are shown in the columns. Group dimming values and/or color temperature values for the scene can be specified in the cells. If the scene for the corresponding group is not relevant, this is indicated by a "-". Dimming values, color temperature values, and "-" can be edited directly in the cell.

The dimming value and the color temperature value can also be edited in a dropdown menu.

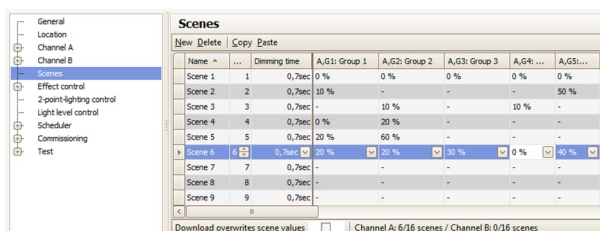

Fig. 23 Scene parameters window

Parameters window menu	
New	A new scene is added.
Delete	The marked scene(s) is/are deleted.
Copy	The marked scene is copied to the clipboard
Paste	The scene from the clipboard is added as a new scene.

The following parameters can be set for each scene:

Parameters	Settings
Name	(max. 25 characters)
This parameter assigns each scene a name with a maximum of 25 characters.	
Scene number	1 - 64
This parameter can assign a scene a number x in the range 1 to 64 (scene number).	
The number of scenes used is shown in the status line. If the maximum number is reached, a failure message is generated.	

07 B0 KNX / DALI Gateway Twin N 141/31 983D11
 07 B0 KNX / DALI Gateway Twin plus N 141/21 983411
 07 B0 KNX / DALI Gateway plus N 141/03 983711

Dimming time	Start-up 0.7 seconds 1.0 seconds 1.4 seconds 2.0 seconds 2.8 seconds 4.0 seconds 5.7 seconds 8.0 seconds 11.3 seconds 16.0 seconds 22.6 seconds 32.0 seconds 45.3 seconds 64.0 seconds 90.5 seconds
---------------------	---

The "Dimming time" parameter equals, on calling up a scene, that time in which the dimming process is concluded jointly for all lights. The dimming time also applies to the dimming of the color temperature
 For example, if the channel A lights are at 50% and should be dimmed in this scene to 90% and if the channel B lights should be dimmed from 100% to 20%, then the dimming process should be concluded simultaneously for both lights. Therefore, channel A will have a flatter dimming curve than channel B.
 A scene's dimming time is independent of the dimming times set for groups.
Note: Different dimming times (both while dimming a new value and during joint dimming of new values in scenes) lead when sending the dimming value or a scene call-up to a reprogramming of the internal dimming time for the relevant ECG, which can cause delays to the scene call-up. If dimming times are changed constantly through scene call-ups at very short intervals (this can, for example, happen with color light control over quickly changing scenes), then this can lead long term to damage to some manufacturers' ECGs. This problem does not arise if the same dimming times are used for all scene call-ups and, with this, as far as possible the standard dimming time of 0.7 seconds.

Each scene can be assigned a number of groups, with the dimming values also being determined for these with scene call-up.

Scene	Settings
Columns	Settings
[Channel], E[Number ECG]: [ECG name] Example: A, E1: ECG1	
All configured groups or ECGs are listed in columns. Only planned groups and ECGs are set to the configured brightness for scene call-up. All unplanned groups and ECGs remain excluded when the scene is called up.	
Scene value (0% - 100%)	"-" 0%-100%
Call-up by drop-down menu <input checked="" type="checkbox"/> : This value gives the dimming value as a percentage, which the group assumes when calling up this scene. The value can be planned for each group for the first time here. On saving the scene later with a scene button, the data is overwritten. The application program automatically limits the entered value to the range between minimum and maximum dimming values. The selection box in the status line determines whether the scene values should be overwritten during the download. Overwrite should be activated for the first download.	
Color temperature (1000K – 20000K)	"-" 1000K-20000K
Call-up via drop-down menu <input checked="" type="checkbox"/> : This value gives the color temperature value in Kelvin, which the group (ECG) assumes when calling up this scene. The value can be planned for each group for the first time here. On saving the scene later with a scene button, the data is overwritten. The application program automatically limits the entered value to the range between minimum and maximum color temperature values. The selection box in the status line determines whether the scene values should be overwritten during the download. Overwrite should be activated for the first download.	

07 B0 KNX / DALI Gateway Twin N 141/31 983D11
 07 B0 KNX / DALI Gateway Twin plus N 141/21 983411
 07 B0 KNX / DALI Gateway plus N 141/03 983711

Download overwrites scene values	<input checked="" type="checkbox"/> (activated)
<p>This parameter determines whether the dimming values saved in the gateway should be overwritten during the download by the dimming values set in the parameters window. Standard is overwriting.</p> <p>When saving new scene values, the ECG value is not polled via DALI, but the internally calculated value is used. This value is then written into the ECG.</p> <p>Note: When you leave the plug-ins with OK, there is this note displayed, which is by no longer show "note" to deactivate and via the menu Options - General - "Show download options at closing".</p>	
	

Scenes are saved and called up via the 8-bit communication object "8-bit scene, Call up/Save".

Object name	Function	Type	Flag																																									
8-bit scene	recall/save	1 byte 18.001	CW																																									
<p>This object recalls or saves the 8-bit scene with the scene number x (i.e. recalled). Bits 0...5 include the scene number x-1 for this. If bit 7 = logical 1, then the scene is programmed and if bit 7 = logical 0, then it is called up. Bit 6 is currently spare and must be set to logical 0.</p> <table border="1" style="width: 100%; border-collapse: collapse; margin-bottom: 10px;"> <tr> <td style="width: 20%;">Bit 7</td> <td style="width: 20%;">6</td> <td style="width: 60%;">5...0</td> </tr> <tr> <td>save</td> <td>"0":</td> <td>Scene number x - 1</td> </tr> <tr> <td colspan="3">Scene (DPT_SceneControl)</td> </tr> </table> <table style="width: 100%; border-collapse: collapse;"> <tr> <td style="width: 33%;">Scene x</td> <td style="width: 33%;">call-up</td> <td style="width: 33%;">save</td> </tr> <tr> <td>1</td> <td>0</td> <td>128</td> </tr> <tr> <td>2</td> <td>1</td> <td>129</td> </tr> <tr> <td>3</td> <td>2</td> <td>130</td> </tr> <tr> <td>...</td> <td>...</td> <td>...</td> </tr> <tr> <td>64</td> <td>63</td> <td>191</td> </tr> </table>				Bit 7	6	5...0	save	"0":	Scene number x - 1	Scene (DPT_SceneControl)			Scene x	call-up	save	1	0	128	2	1	129	3	2	130	64	63	191														
Bit 7	6	5...0																																										
save	"0":	Scene number x - 1																																										
Scene (DPT_SceneControl)																																												
Scene x	call-up	save																																										
1	0	128																																										
2	1	129																																										
3	2	130																																										
...																																										
64	63	191																																										
8-bit scene with dimming time	recall	3 byte	CW																																									
<p>This object calls up the 8-bit scene with the number x (i.e. recalled). Bits 0...5 contain the scene number x for this. If Bit 7 = logical 1, then the object is ignored (i.e. no scene called up or saved). If Bit 7 = logical 0, then it is called up. Bit 6 is currently spare and must be set to logical 0.</p> <table border="1" style="width: 100%; border-collapse: collapse; margin-bottom: 10px;"> <tr> <td style="width: 12.5%;">Bit 23</td><td style="width: 12.5%;">22</td><td style="width: 12.5%;">21</td><td style="width: 12.5%;">20</td><td style="width: 12.5%;">19</td><td style="width: 12.5%;">18</td><td style="width: 12.5%;">17</td><td style="width: 12.5%;">16</td> </tr> <tr> <td colspan="8">Dimming time (DPT_TimePeriod100MSec, high byte)</td> </tr> </table> <table border="1" style="width: 100%; border-collapse: collapse; margin-bottom: 10px;"> <tr> <td style="width: 12.5%;">Bit 15</td><td style="width: 12.5%;">14</td><td style="width: 12.5%;">13</td><td style="width: 12.5%;">12</td><td style="width: 12.5%;">11</td><td style="width: 12.5%;">10</td><td style="width: 12.5%;">9</td><td style="width: 12.5%;">8</td> </tr> <tr> <td colspan="8">Dimming time (DPT_TimePeriod100MSec, low byte)</td> </tr> </table> <table border="1" style="width: 100%; border-collapse: collapse;"> <tr> <td style="width: 20%;">Bit 7</td> <td style="width: 20%;">6</td> <td style="width: 60%;">5...0</td> </tr> <tr> <td>save</td> <td>"0":</td> <td>Scene number x - 1</td> </tr> <tr> <td colspan="3">Scene (DPT_SceneControl)</td> </tr> </table> <p>Only certain dimming times (see dimming time parameter) can be processed. The dimming times are therefore rounded down to the next possible value.</p>				Bit 23	22	21	20	19	18	17	16	Dimming time (DPT_TimePeriod100MSec, high byte)								Bit 15	14	13	12	11	10	9	8	Dimming time (DPT_TimePeriod100MSec, low byte)								Bit 7	6	5...0	save	"0":	Scene number x - 1	Scene (DPT_SceneControl)		
Bit 23	22	21	20	19	18	17	16																																					
Dimming time (DPT_TimePeriod100MSec, high byte)																																												
Bit 15	14	13	12	11	10	9	8																																					
Dimming time (DPT_TimePeriod100MSec, low byte)																																												
Bit 7	6	5...0																																										
save	"0":	Scene number x - 1																																										
Scene (DPT_SceneControl)																																												

07 B0 KNX / DALI Gateway Twin N 141/31 983D11 07 B0 KNX / DALI Gateway Twin plus N 141/21 983411 07 B0 KNX / DALI Gateway plus N 141/03 983711

Calling up a scene interrupts the time functions currently running (timer mode/night mode) and the value reset by the call-up remains received indefinitely.

When saving new scene values, the ECG value is not polled via DALI, but the internally calculated value is used. This value is then written into the ECG.

07 B0 KNX / DALI Gateway Twin N 141/31 983D11
 07 B0 KNX / DALI Gateway Twin plus N 141/21 983411
 07 B0 KNX / DALI Gateway plus N 141/03 983711

14. Effects controller

The "Effects controller" function makes it possible to define a sequential control for sending colored light change, scene change, switching commands, etc. This allows commands to be defined in single steps which run consecutively with and without delays. Four effects can be defined in parallel which send independent commands via the effects channel. The effects can be run several times or infinitely. The current status (active, stopped) can be displayed by a status object. A total of 1000 steps are possible.

Procedure:

1. Create effects channels
2. Create effects
3. Configure and assign effects in the effects channels
4. Assign group addresses to the objects

14.1 Effects channels

Up to 20 effects channels can be defined which execute the individual commands in connection with a group address. These can be created in the corresponding parameters window.

Effect channels		
New Delete Copy Paste		
Nr	Name	Type
1	Effect channel 1	on / off
2	Effect channel 2	Dimming value
3	Effect channel 3	Scene
4	Effect channel 4	Dimming value
5	Effect channel 5	Dimming value

Fig. 24 Effects channels parameters window

Parameters window menu	
New	A new effects channel is added.
Delete	The marked effects channel is deleted.
Copy	The marked effects channel is copied to the clipboard.
Paste	The effects channel from the clipboard is added as a new effects channel.

An effects channel contains the following parameters:

Effect control	
Effect channels	
Column	Settings
No.	
Consecutive number of the effects channel.	
Name (25 characters)	
This parameter can be used to assign an effect channel a name with a maximum of 25 characters. This name is used in the communication object description.	
Type	On/Off Off if dimming value < minimum dimming value Dimming value/time Scene Scene with dimming time Color temperature
This parameter is used to set which type of object the effects channel should have.	

07 B0 KNX / DALI Gateway Twin N 141/31 983D11
 07 B0 KNX / DALI Gateway Twin plus N 141/21 983411
 07 B0 KNX / DALI Gateway plus N 141/03 983711

One of the following communication objects is available for each effects channel, depending on the set type.

Object name	Function	Type	Flag																								
[Name], Switching	On/Off	1 bit 1.001	CRWT																								
This object is used to send an "On" or "Off" command.																											
[Name], Dimming value	8-bit value	1 byte 5.001	CRWT																								
This object can be used to send a dimming value to be triggered.																											
[Name], Dimming value/time	Dimming value +dimming time	3 byte	CRWT																								
This object can be used to send a dimming value to be triggered with the sent dimming time.																											
<table border="1" style="width: 100%; border-collapse: collapse;"> <tr> <td style="width: 12.5%;">Bit 23</td> <td style="width: 12.5%;">22</td> <td style="width: 12.5%;">21</td> <td style="width: 12.5%;">20</td> <td style="width: 12.5%;">19</td> <td style="width: 12.5%;">18</td> <td style="width: 12.5%;">17</td> <td style="width: 12.5%;">16</td> </tr> <tr> <td colspan="8">Dimming time (DPT_TimePeriod100MSec, high byte)</td> </tr> </table>				Bit 23	22	21	20	19	18	17	16	Dimming time (DPT_TimePeriod100MSec, high byte)															
Bit 23	22	21	20	19	18	17	16																				
Dimming time (DPT_TimePeriod100MSec, high byte)																											
<table border="1" style="width: 100%; border-collapse: collapse;"> <tr> <td style="width: 12.5%;">Bit 15</td> <td style="width: 12.5%;">14</td> <td style="width: 12.5%;">13</td> <td style="width: 12.5%;">12</td> <td style="width: 12.5%;">11</td> <td style="width: 12.5%;">10</td> <td style="width: 12.5%;">9</td> <td style="width: 12.5%;">8</td> </tr> <tr> <td colspan="8">Dimming time (DPT_TimePeriod100MSec, low byte)</td> </tr> </table>				Bit 15	14	13	12	11	10	9	8	Dimming time (DPT_TimePeriod100MSec, low byte)															
Bit 15	14	13	12	11	10	9	8																				
Dimming time (DPT_TimePeriod100MSec, low byte)																											
<table border="1" style="width: 100%; border-collapse: collapse;"> <tr> <td style="width: 12.5%;">Bit 7</td> <td style="width: 12.5%;">6</td> <td style="width: 12.5%;">5</td> <td style="width: 12.5%;">4</td> <td style="width: 12.5%;">3</td> <td style="width: 12.5%;">2</td> <td style="width: 12.5%;">1</td> <td style="width: 12.5%;">0</td> </tr> <tr> <td colspan="8">Dimming value (DPT_Scaling)</td> </tr> </table>				Bit 7	6	5	4	3	2	1	0	Dimming value (DPT_Scaling)															
Bit 7	6	5	4	3	2	1	0																				
Dimming value (DPT_Scaling)																											
[Name], Scene	Call up	1 byte 18.001	CRWT																								
This object can be used to send a scene to be called up.																											
[Name], Scene with dimming time	Call up	3 byte	CRWT																								
This object can be used to send a scene to be called up with the sent dimming time.																											
<table border="1" style="width: 100%; border-collapse: collapse;"> <tr> <td style="width: 12.5%;">Bit 23</td> <td style="width: 12.5%;">2</td> <td style="width: 12.5%;">21</td> <td style="width: 12.5%;">20</td> <td style="width: 12.5%;">19</td> <td style="width: 12.5%;">18</td> <td style="width: 12.5%;">17</td> <td style="width: 12.5%;">16</td> </tr> <tr> <td colspan="8">2</td> </tr> <tr> <td colspan="8">Dimming time (DPT_TimePeriod100MSec, high byte)</td> </tr> </table>				Bit 23	2	21	20	19	18	17	16	2								Dimming time (DPT_TimePeriod100MSec, high byte)							
Bit 23	2	21	20	19	18	17	16																				
2																											
Dimming time (DPT_TimePeriod100MSec, high byte)																											
<table border="1" style="width: 100%; border-collapse: collapse;"> <tr> <td style="width: 12.5%;">Bit 15</td> <td style="width: 12.5%;">14</td> <td style="width: 12.5%;">13</td> <td style="width: 12.5%;">12</td> <td style="width: 12.5%;">11</td> <td style="width: 12.5%;">10</td> <td style="width: 12.5%;">9</td> <td style="width: 12.5%;">8</td> </tr> <tr> <td colspan="8">Dimming time (DPT_TimePeriod100MSec, low byte)</td> </tr> </table>				Bit 15	14	13	12	11	10	9	8	Dimming time (DPT_TimePeriod100MSec, low byte)															
Bit 15	14	13	12	11	10	9	8																				
Dimming time (DPT_TimePeriod100MSec, low byte)																											
<table border="1" style="width: 100%; border-collapse: collapse;"> <tr> <td style="width: 12.5%;">Bit 7</td> <td style="width: 12.5%;">6</td> <td style="width: 12.5%;">5</td> <td style="width: 12.5%;">4</td> <td style="width: 12.5%;">3</td> <td style="width: 12.5%;">2</td> <td style="width: 12.5%;">1</td> <td style="width: 12.5%;">0</td> </tr> <tr> <td colspan="8">Scene (DPT_SceneControl)</td> </tr> </table>				Bit 7	6	5	4	3	2	1	0	Scene (DPT_SceneControl)															
Bit 7	6	5	4	3	2	1	0																				
Scene (DPT_SceneControl)																											
[Name], color temperature	16-bit value	2 byte 7,006	KS																								
This object can be used to send a color temperature value to be triggered.																											

07 B0 KNX / DALI Gateway Twin N 141/31 983D11
 07 B0 KNX / DALI Gateway Twin plus N 141/21 983411
 07 B0 KNX / DALI Gateway plus N 141/03 983711

14.2 Effects

Effects			
New Delete Copy Paste			
Nr	Name	Effect number	Cycles (0 = loop)
1	Effect 1	1	0
2	Effect 2	2	0
3	Effect 3	3	0
4	Effect 4	4	0

Fig. 25 Effects parameters window

Parameters window menu	
New	A new area is added.
Delete	The marked area is deleted.
Copy	The marked area is copied to the clipboard
Paste	The area from the clipboard is added as a new area.

An effect is started and ended by the 8-bit "Effect" communication object.

The following parameters can be set for each effect.

Column	Settings
No.	
Consecutive number of the effect.	
Name (25 characters)	
This parameter can be used to assign an effect a name with a maximum of 25 characters. This is used in the communication object description.	
Effect number	1-64
This parameter can assign an effect a number in the range 1 to 64 (effect number).	
Cycles (0 = infinite)	0-500 0
This parameter is used to define how often the effect should be run when it is called up. If the parameter is set to "0", then the effect runs until it is stopped by a call-up of its number and by Bit 7 set to logical 1.	

07 B0 KNX / DALI Gateway Twin N 141/31 983D11
 07 B0 KNX / DALI Gateway Twin plus N 141/21 983411
 07 B0 KNX / DALI Gateway plus N 141/03 983711

14.3 Effect step

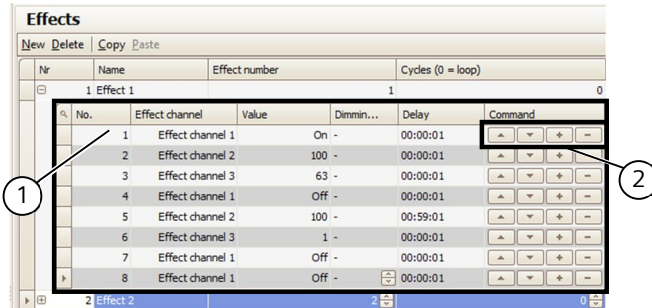

- (1) Effect steps for Effect 1
- (2) Effect steps buttons

Fig. 26 Effects and effect steps parameters window

The following parameters can be set for each effect step.

Effect control	
Effect channels	
Column	Settings
No.	
Consecutive number of the effect step.	
Effect channel	
The effect channel for performing an action is selected in this column.	
Value	On, Off 0 – 100 1 – 64 1000K – 20000K
This parameter defines the value which is sent by the corresponding object for this effect step.	
Dimming time	12:00:00 AM – 1:45:00 AM 12:00:00 AM
This parameter is not enabled unless the type is expecting a dimming time.	
Pause	12:00:00 AM – 3:00:00 PM 00:01 AM
This time specifies the waiting time after execution of the effect step before the next step is started. The effect steps can overlap if the set delay is too short. This is displayed by a warning message.	
Buttons	
[Up] [Down]	
These buttons are used to shift the single steps down and up in the sequence. This makes it possible to edit the execution sequence.	
[+] [-]	
The "+" buttons make it possible to add a new effect step below. The "-" buttons make it possible to delete an effect step.	

07 B0 KNX / DALI Gateway Twin N 141/31 983D11
 07 B0 KNX / DALI Gateway Twin plus N 141/21 983411
 07 B0 KNX / DALI Gateway plus N 141/03 983711

14.4 Objects and parameters

Object name	Function	Type	Flag																		
Effect	start/stop	1 byte	CW																		
This object is used to start or end the effect with the number x. Bits 0...5 contain the effect number x for this. If Bit 7 = logical 0, then the effect is started. If Bit 7 = logical 1, then it is ended. Bit 6 is currently spare and must be set to logical 0. Other currently running effects are not stopped when an effect is started.																					
<table border="1" style="width: 100%; text-align: center;"> <tr> <td style="width: 33%;">Bit 7 start / stop</td> <td style="width: 33%;">6 not used</td> <td style="width: 33%;">5 ...0 Effect number x -1</td> </tr> </table>				Bit 7 start / stop	6 not used	5 ...0 Effect number x -1															
Bit 7 start / stop	6 not used	5 ...0 Effect number x -1																			
<table style="width: 100%; border-collapse: collapse;"> <tr> <td style="width: 10%;">Effect</td> <td style="width: 10%;">start</td> <td style="width: 10%;">end</td> </tr> <tr> <td>1</td> <td>0</td> <td>128</td> </tr> <tr> <td>2</td> <td>1</td> <td>129</td> </tr> <tr> <td>3</td> <td>2</td> <td>130</td> </tr> <tr> <td>...</td> <td>...</td> <td>...</td> </tr> <tr> <td>64</td> <td>63</td> <td>191</td> </tr> </table>				Effect	start	end	1	0	128	2	1	129	3	2	130	64	63	191
Effect	start	end																			
1	0	128																			
2	1	129																			
3	2	130																			
...																			
64	63	191																			
Effect,[Name], Status	1=running	1 bit 1.011	KL																		
This object can be used to send the current status of every effect. Depending on the configuration. The object is only visible if the configuration has been selected accordingly.																					

General	
Status messages	
Parameter	Settings
Effect, Status objects	No Send only on read request Send on status change Send on status change/bus voltage recovery
This parameter sets whether an "Effect, [Effect name], Status" communication object should be displayed for each effect and when these objects should be sent. Sending is not automatic if the setting is "send only on read request". Sending the status on a read request is possible with any parameter setting except the parameter "no". "Send on status change" sends the current status independently via the communication object after a change. The status is not sent automatically when the bus voltage is restored, even if it is changed in accordance with the setting. The setting "Send on status change/bus voltage recovery" automatically sends the current status after a change, as well as independently upon the bus voltage recovery.	

07 B0 KNX / DALI Gateway Twin N 141/31 983D11
 07 B0 KNX / DALI Gateway Twin plus N 141/21 983411
 07 B0 KNX / DALI Gateway plus N 141/03 983711

15. 2-point lighting control

15.1 Description

The controller works functionally as an independent function block. Up to sixteen (16) 2-point controllers can be created. If the controller is enabled, the lighting is switched on as soon as the lower brightness falls below the set threshold. The lighting is switched off if the set upper brightness threshold has been exceeded. Brightness thresholds can be varied using parameters or communication objects.

By means of isolation into two individual switching objects for breaching the upper and lower thresholds, the controller can also be operated as a "Semi-automat (only off)". It can therefore be switched to "Only On" or "Only Off". If the controller receives a switching, dimming, or dimming value command or one of the defined scene commands from the associated object, then this is assessed as an external override and the controller switches the controller off. The "Controller Status" object sends this status change simultaneously.

The controller input signals can originate both from the internal objects and from external bus subscribers. If the criterion meets a threshold value overshoot or shortfall, then this is not sent to the bus immediately. The analysis unit first forwards a signal, if it has not changed its value over a defined period. This measure has the effect that short term brightness fluctuations do not lead directly to switching of the lighting.

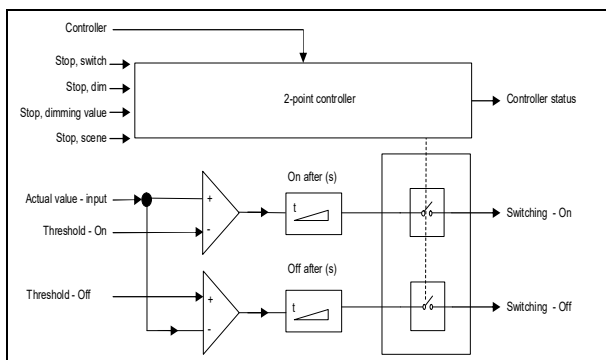

Fig. 27 2-point control function block

The controller internally knows two states: It is either On (= status controller) or Off.

The "Controller" object switches the controller on with (logical 1). If the controller is switched off manually via this object (logical 0), no value is sent to the start object.

The behavior without received brightness value for the two-point controller is described below:

While no brightness value has been received, neither is a switching command sent. The remaining behavior remains in existence. That a value has been received also remains saved after a partial download.

07 B0 KNX / DALI Gateway Twin N 141/31 983D11
 07 B0 KNX / DALI Gateway Twin plus N 141/21 983411
 07 B0 KNX / DALI Gateway plus N 141/03 983711

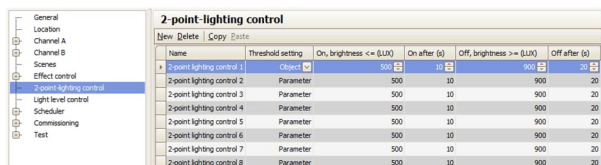

Fig. 28 2-point control parameters window

Parameters window menu	
New	A new controller is added.
Delete	The marked controller(s) is/are deleted.
Copy	The marked controller is copied into the clipboard.
Paste	The controller from the clipboard is added as a new controller.

2-point-lighting control	
Parameters	Settings
Name	(max. 25 characters)
This parameter assigns a 2-point controller a name with a maximum of 25 characters which is used again in the object description.	
Threshold specification	Parameter Object
This parameter is used to set whether the threshold values with the controller as a parameter is set to a fixed value that can respectively only be changed with the help of the ETS (Engineering Tool Software) or whether the corresponding parameter set by the manufacturer should be changeable via two objects at any time. The values received via objects immediately overwrite the parameter value set by the manufacturer and are stored permanently. <u>Note:</u> The controller's range can be extended via the objects. "On" Threshold < 1 Lux and "Off" threshold > 64.000 Lux are possible. It is recommended that the variable control range be observed.	
On, brightness <= (LUX)	1 - 64000 500
This parameter determines from which brightness value the "Switch on" telegram is sent. If the brightness threshold for switching on is > the brightness threshold for switching off, the value for switching on by the controller is set, to the value for switching off, i.e. both values are identical. This means that the controller still sends only one telegram to switch on. In this case, it has to be switched off manually.	
ON after (s)	0 – 59 10
This parameter sets a delay only after which the ON telegram is sent.	
OFF, brightness >= (LUX)	1 - 64000 900
This parameter sets which brightness reading has to be reached or exceeded so that the lighting is switched off by the controller.	
OFF after (s)	0 - 59 20
This parameter sets a delay only after which the OFF telegram is sent.	
Controller off for scenes	- 1 - 64
A selection list can be used to select all scene numbers which shut off the controller when received via the "[Name], Stop Scene" object. The controller can be switched on again only by receiving "logical 1" on the "Controller" object.	

07 BO KNX / DALI Gateway Twin N 141/31 983D11
 07 BO KNX / DALI Gateway Twin plus N 141/21 983411
 07 BO KNX / DALI Gateway plus N 141/03 983711

15.2 Objects

Object name	Function	Type	Flag
[Name], Actual value input	Brightness (Lux)	2 byte 9.004	CRW
The brightness value that is used for the controller is received via this communication object.			
[Name], controller	On/Off	1 bit 1.001	CWT
This "On" object can be used to switch the controller on or off. This information can, for example, come from a bus button or from a presence detector start object. If the controller is switched on by this object, then it is also used to reset the times in the delay times. If the controller is switched off manually, no value is sent on the start object.			
[Name], controller status	On/Off	1 bit 1.001	CRT
The controller uses this object to report the status. This can have either the value "On", i.e. the controller is working in automatic mode, or the value "Off". Neither is there any distinction as to whether the controller was switched off manually or by override.			
[Name], On threshold	Brightness (Lux)	2 byte 9.004	CRW
This sets the threshold value externally for switching on the 2-point controller. Until the first incoming value, the value from the "Threshold value" parameter is used as the standard value. This object is visible only if the "Threshold specification" parameter is set on the object.			
[Name], Off threshold	Brightness (Lux)	2 byte 9.004	CRW
This sets the threshold value externally for switching off the 2-point controller. Until the first incoming value, the value from the "Threshold value" parameter is used as the standard value. This object is visible only if the "Threshold specification" parameter is set on the object.			
[Name], Stop	Switching	1 bit 1.001	CWT
If a value is received via this object (logical 0 or 1), the controller switches off, because it has been overwritten from outside. The controller can be switched on again only by receiving "logical 1" at the "Controller On/Off" object.			
[Name], Stop	Dim	4 bit 3.007	CWT
If a value is received via this object, the controller is switched off, because it has been overwritten from outside. The controller can be switched on again only by receiving "logical 1" at the "Controller On/Off" object.			
[Name], Stop	Off if dimming value < minimum dimming value	1 byte 5.001	CWT
If a value is received via this object (0...255), the controller is switched off, because it has been overwritten from outside. The controller can be switched on again only by receiving "logical 1" at the "Controller On/Off" object.			
[Name], Stop	Scene	1 byte 17.001	CWT
If a scene value is received via this object (0...63), then the controller switches off if the associated scene number is selected in the "Controller off for scene" parameter field. The controller can be switched on again only by receiving "logical 1" at the "Controller On/Off" object.			
[Name], Switching	On	1 bit 1.001	CWT
This object is one of the two outputs from the 2-point controller. It sends a value (On), if the brightness is below the set brightness value in a given period.			
[Name], Switching	Off	1 bit 1.001	CWT
This object is one of the two outputs from the 2-point controller. It sends a value (Off), if the brightness is above the set brightness value in a given period.			

07 B0 KNX / DALI Gateway Twin N 141/31 983D11 07 B0 KNX / DALI Gateway Twin plus N 141/21 983411 07 B0 KNX / DALI Gateway plus N 141/03 983711
--

15.3 Behavior during emergency mode

The controller is switched off if emergency mode is received via the general emergency mode object. It then behaves as if the controller was switched off by the "Controller" object. No additional objects are sent. If emergency mode is cancelled again, the controller remains off.

07 B0 KNX / DALI Gateway Twin N 141/31 983D11
07 B0 KNX / DALI Gateway Twin plus N 141/21 983411
07 B0 KNX / DALI Gateway plus N 141/03 983711

16. Constant lighting control

16.1 Overview

The controller works functionally as an independent function block. Up to sixteen (16) constant light controllers can be created. The controller input signals can originate both from the internal objects and from external bus subscribers.

If the controller is activated, then the lighting is dimmed to the value which is necessary, for example, to achieve the brightness required at the workstation. The controller thus enhances the existing natural light with only enough artificial light to prevent the set target brightness value from being fallen short of.

The controller is able to control one lighting group and up to four lighting subgroups. This can particularly be used in rooms, in which the natural light coming in through the windows loses its brightness in the depths of the room.

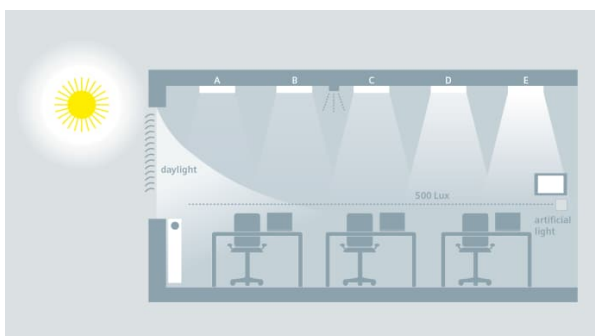

Fig. 29 Natural light distribution in the room

07 B0 KNX / DALI Gateway Twin N 141/31 983D11
 07 B0 KNX / DALI Gateway Twin plus N 141/21 983411
 07 B0 KNX / DALI Gateway plus N 141/03 983711

16.2 Controller for a lighting group

The following principle controller design results for the control of an individual lighting group. The lighting group is described as a main lighting group.

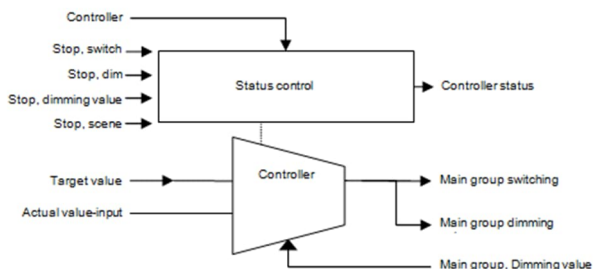

Fig. 30 Controller for a lighting group

Depending on the light, the lighting is adjusted to the specified setpoint by dimming actuators or by switching/dimming actuators with the setpoint being selectable as a parameter or object.

In the case of just one lighting group, the controller has only one output for the dimming value (8-bit) variable and for switching.

The variable is derived directly from the result of the controller. The variable can be restricted, however, for each ETS parameter. It is thus possible that the lights are dimmed by around 5% in heavy sunlight, for example, to reduce the number of on/off switching operations.

A final automatic shut-down is possible, for example, if the lamps are set to minimum brightness for 10 minutes and it is very bright in the room.

The constant light controller can internally take on four different states in operation.

Active: The actual control occurs in this state. This means that a comparison between the target and actual value is performed at certain time intervals (configurable) and a variable is output, depending on the deviation.

Inactive: The controller also acts passively in this state, i.e. although it is virtually still activated, it does not perform any more controller activities.

Standby: The controller also acts passively in this state. The difference from the "inactive" state, however, is that a comparison between the target and actual value also continues to be performed. When a corresponding difference exists between the target and actual value, the controller switches independently to the active state.

Off: The controller is stopped and the output objects initially dimmed to minimum and completely shut off a second later by dimming.

The controller internally knows two states: It is either On (= status controller) or Off.

The "Controller On/Off" object switches the controller on with logical 1. If the controller is manually shut off (logical 0) by this object, then parameters can be used to define whether and which value is sent to the output object controller.

If the controller receives a value from another bus subscriber on one of the following objects: Input, switching (1 bit) or input, switching (4 bit) or input / output, analogue value (8 bit) (or scene), then it is accessed as an external override and the controller shuts off. The "Controller Status" object sends this status change simultaneously.

07 B0 KNX / DALI Gateway Twin N 141/31 983D11
07 B0 KNX / DALI Gateway Twin plus N 141/21 983411
07 B0 KNX / DALI Gateway plus N 141/03 983711

16.3 Controller for multiple lighting groups

The controller is able to control one main lighting group and additionally up to four lighting subgroups. This can particularly be used in rooms, in which the natural light coming in through the windows loses its brightness in the depths of the room.

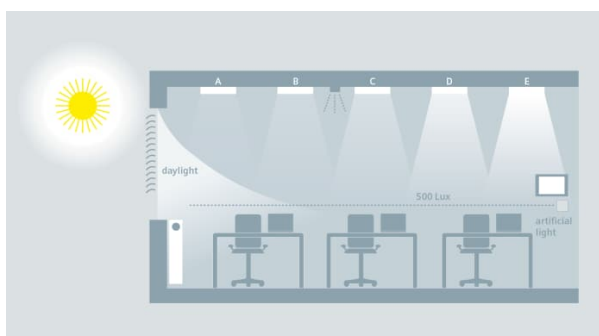

Fig. 31 Natural light distribution in the room

The controller consists of five individual controllers linked together with one output each for the dimming value (8-bit) and a switching object (1-bit). This makes it possible to simultaneously control one main group and four subgroups with one controller. This means that the variables for the subgroups are directly derived from the variable of the main group.

07 B0 KNX / DALI Gateway Twin N 141/31 983D11
 07 B0 KNX / DALI Gateway Twin plus N 141/21 983411
 07 B0 KNX / DALI Gateway plus N 141/03 983711

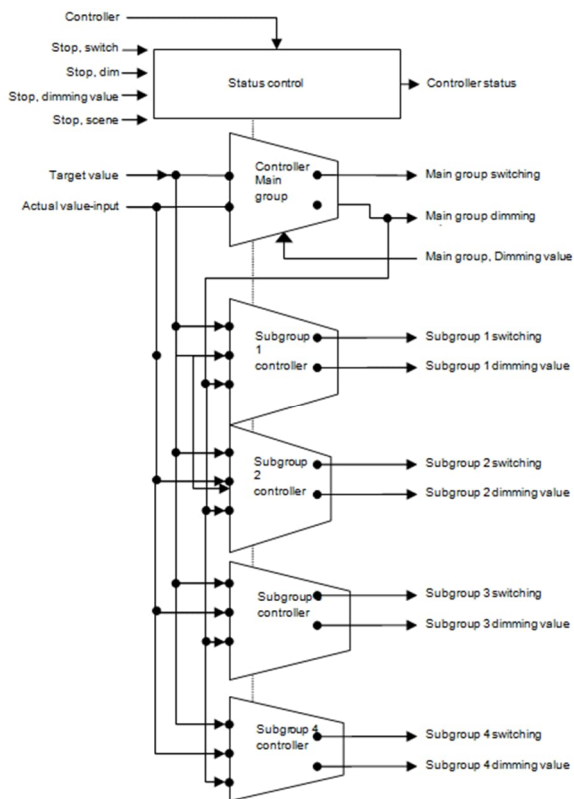

Fig. 32 Controller setup for several lighting groups

07 B0 KNX / DALI Gateway Twin N 141/31 983D11
 07 B0 KNX / DALI Gateway Twin plus N 141/21 983411
 07 B0 KNX / DALI Gateway plus N 141/03 983711

All of the lighting groups are dimmed to the same target value (e.g. 500 Lux). This makes it possible to control the brightness in a room with just one brightness sensor. Depending on whether the lighting subgroups are closer to or further away from the window than the main lighting group, the respective lighting subgroup must be dimmed darker or brighter accordingly (→ Fig. 32)

The controller for multiple lighting groups is a combination of one controller and one control unit. The advantage lies in the fact that up to five different lighting groups can be individually controlled by just one controller.

The drawback is that the parameters for the lighting subgroups are complex to adjust and that even with careful commissioning, the brightness of the subgroups in the adjusted state may not correspond to the expected brightness. The difficulty lies in the detection of the interference light (sun, additional light in the room).

The difference is that the brightness (actual value) can only be measured for the main lighting group. The variables for the controller of the subgroup lights are derived from the actual value, the variable of the main group and the corresponding algorithms.

It must first be determined for this where the room's brightness is measured. The brightness sensor, usually in combination with a presence detector, can be installed at positions A - E on the ceiling. The position of the brightness sensors, which determine the main lighting group, is generally freely selectable, but should be as close to the window as possible to optimally record the natural light.

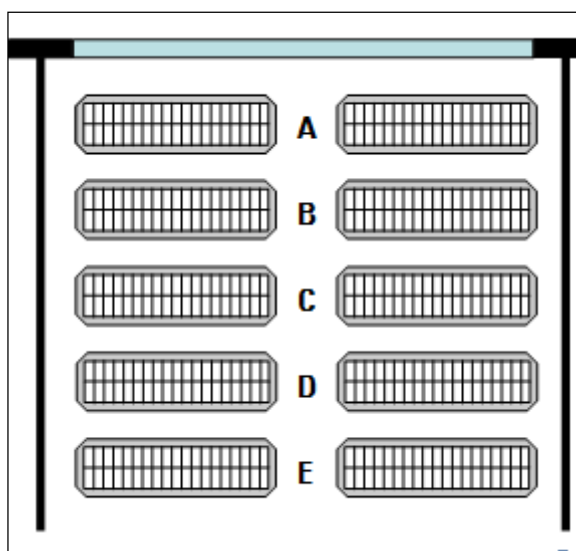

Fig. 33 Position of the brightness sensor

07 B0 KNX / DALI Gateway Twin N 141/31 983D11
 07 B0 KNX / DALI Gateway Twin plus N 141/21 983411
 07 B0 KNX / DALI Gateway plus N 141/03 983711

16.3.1 Computation method - offset

With this process, the variables for the subgroups are derived from the variable by addition/subtraction. One parameter specifies the size of the offset (= correction value) for the respective subgroup. A value range of -100% to +100% can be adjusted for this. 100% is based on the maximum variable of 255. A negative variable is not possible.

Example:

Main group variable = 20
 Subgroup offset 1 = +10% (10% of 255)
 → Subgroup 1 variable = 20 + 25.5 = 46

Before the calculated variable can be output on the bus, it is checked with respect to its permissible value range [0% ... 100%] (configurable). If the value lies outside of the permissible range, then it will be limited to the range limits. If the main groups calculated value changes, then the subgroups are also resent. Even if the new value of a subgroup is identical to the previous value.

16.3.2 Computation method - characteristic curve

This method uses the progression of natural and artificial light along the lighting groups A-E in the room to determine the characteristic curve for controlling the individual lighting groups.

Determination of the natural light pattern:

For this method, a brightness meter must be used to measure the natural light pattern under the lighting groups A – E. This room lighting must be completely shut off for this so that the room is solely illuminated by natural light. The natural light is ideally uniform (no cast shadows), bright and diffuse, e.g. on a bright day with a cloudy sky at noon. The lighting strength (Lux) must then be measured manually under every lighting group and this value entered in the configuration.

Determination of the artificial light pattern:

The characteristic curve for the lighting subgroups must be determined without natural light. The room must be completely darkened for this or the control characteristic curve recorded at night. The recording of the characteristic curve is started by sending a start signal to the "Calibration" object. The controller independently generates 15 discrete variables in the range of 0%...100% for the main lighting group and the lighting subgroups. The controller records the resulting lighting strength. The distance between the measurements can be selected to be between 10 and 60 seconds to facilitate optimal preheating of the lights. The 15 measured brightness values can be recorded by the "Diagnostic values" object for diagnostic purposes.

The controller goes into the "inactive" state following successful completion or interruption of the calibration.

07 B0 KNX / DALI Gateway Twin N 141/31 983D11
 07 B0 KNX / DALI Gateway Twin plus N 141/21 983411
 07 B0 KNX / DALI Gateway plus N 141/03 983711

16.4 Parameter

Constant lighting control	
Parameter	Settings
Name (25 characters)	
This parameter can assign a name with a maximum of 25 characters. This name is used in the object description.	
Constant lighting control	
Name (25 characters)	
Target value	
Parameters	Settings
Target value specification	Parameter Object
The target value can either be specified as a fixed value or by an object. As the target value, either a brightness value can be sent in Lux to the device by the object or the internal target value can be changed by relative dimming commands. If the target value has been changed from outside, then the currently valid value is sent by an object.	
Target value [50 – 1600 Lux]	50 - 1600, 600
The brightness target value for the constant light control is determined within the range of 50 – 1600 Lux. If configured as target value specification with object overwritten, then this parameter provides the starting value if no valid value exists. <u>Note:</u> This setting uses the last on the object "" receive dimming value as the start value when the system starts. If no value is available, the value from the "First dimming value". For setpoints less than 250 lux is in the application to check whether the light control satisfies the requirements. A maximum of 20 is recommended as a correction factor.	
Minimum target value [50 – 1600 Lux]	250 - 1600, 400
This parameter is visible only if the "Target value specification" parameter has been set to "object". It is used to define the lower limit, which applies for the target specification using relative and absolute dimming commands. <u>Note:</u> For setpoints less than 250 lux is in the application to check whether the light control satisfies the requirements. A maximum of 20 is recommended as a correction factor.	
Maximum target value [50 – 1600 Lux] (=Start value)	50 - 1600, 1000
This parameter is visible only if the "Target value specification" parameter has been set to "object". This is used to define the upper limit, which applies for the target specification using relative and absolute dimming commands. If the "maximum target value" was accidentally selected to be less than the "minimum target value", then the "maximum target value" is set internally to ["minimum target value" + 10]. (maximal to 1600 Lux)	

07 B0 KNX / DALI Gateway Twin N 141/31 983D11
 07 B0 KNX / DALI Gateway Twin plus N 141/21 983411
 07 B0 KNX / DALI Gateway plus N 141/03 983711

For each dimming step, the target value changes by	1/64 (2%) 1/32 (3%) 1/16 (6%) 1/8 (13%) 1/4 (25%) 1/2 (50%)
This parameter is visible only if the "Target value specification" parameter has been set to "object". This defines the value by which the brightness target value for the continuous constant light controller must be changed for each dimming step when the "relative target value" object is used.	
Save target value - Relative target value	Immediately via object
This parameter is visible only if the "Target value specification" parameter has been set to "object". This parameter can be used to set whether the target value should be saved immediately or only after a 1 has been received via a "save target value" object when it is shifted by the "relative target value" object.	
Shut-off with target value = 0	No Yes
This parameter is visible only if the "Target value specification" parameter has been set to "object". It is used to define whether the controller should switch to the "Off" state following the receipt of a controller target value "0" by the corresponding object. This causes the controller to end its function while at the same time the actuators shut off the objects with the dimming value 0. Shut-off telegrams are additionally sent if the parameter "Start and end controller with" is set accordingly.	
Start controller with target value greater than 0	No Yes
This parameter is visible only if the "Target value specification" parameter has been set to "object". This defines whether the controller should switch to the "active" state when a target value greater than "0" is received by the object. The specified Lux value is simultaneously the new target value.	
Constant lighting control	
Name (25 characters)	
Controller	
Parameters	Settings
Maximum deviation from the target value (Hysteresis)	+/- 5% +/- 10% +/- 15% +/- 20%
This parameter is used to define the minimum difference between the actual and target value, at which the controller starts to control. This parameter only affects the controller for the main lighting group.	
Send dimming value after (control speed) [sec.]	1 – 20, 1
This parameter is used to define the intervals at which the controller outputs the calculated variables. <u>Note:</u> The 1-second setting is practical when using an external measured value.	

07 BO KNX / DALI Gateway Twin N 141/31 983D11
 07 BO KNX / DALI Gateway Twin plus N 141/21 983411
 07 BO KNX / DALI Gateway plus N 141/03 983711

Time until the controller automatically shuts off [Min] (0 = never)	0 – 230, 3
<p>If the controller variable reaches the specified minimum in the active state and the brightness value is greater than the brightness target value, then the controller switches to the "stand-by" state and sends the switching telegram with the "Off" value.</p> <p>The time from reaching the conditions described above to the change to the "stand-by" state is defined by the above parameter in the range of 1 - 255 minutes. If the parameter is set to "0", then the controller remains in the "active" state with its minimum variables.</p>	
Additional hysteresis for automatic reactivation of the controller [Lux]	0 – 230, 100
<p>If the actual value falls under the value of the target value minus hysteresis minus additional hysteresis in the "stand-by" state, then the controller switches automatically to the "active" state.</p> <p><u>Note:</u> If a value below 50 Lux results from the target value, hysteresis and this additional hysteresis, then this is set to 50 Lux.</p>	
Starting and ending the controller with	dimming value telegram only additionally switching telegram at start additionally switching telegram at stop additionally switching telegram at start and stop
<p>This parameter is used to define which constant light controller telegrams are respectively sent at the beginning and end of the controller activity (change to the "active" state or leave the "active" state).</p> <p>This parameter is used to set whether the lighting should be switched on by an ON switching command following receipt of a telegram, e.g. "Presence = ON" (if the previous status was "Presence = OFF) or by a dimming value command and accordingly by the shut-off of the lighting by a 0% dimming value command or an OFF switching command.</p> <p>If the ON switching command is used for activation, the lighting is switched on to the value configured in the receiver device and starting from this value, slowly dimmed to the value at which the brightness target value and actual value correspond. For this purpose, the controller requests the dimming value status from the receiver device 3 seconds after the switch-on telegram is sent (the switch-on process should normally be completed by then). If the dimming value status is received, then the brightness controller starts at the current actuator dimming value. The light will be dimmed brighter or darker in accordance with the deviation between the actual and target value. If possible, it is therefore recommended to configure the actuator in such a way that it is already dimming to a value when it is switched on, which the constant light controller will later dim to.</p> <p>If the brightness controller does not receive a response from the actuator within 2 seconds following the query, then the controller starts under the assumption of an actuator dimming value of 0% (i.e. the controller starts controlling at the 0% dimming value instead of the actuator's current dimming value). It is then dimmed more brightly until the actual value corresponds to the brightness target value.</p> <p>If the status of the presence is set to "OFF" or if a deactivated controller is switched back to "ON" when a "Presence = ON" telegram is received, then the dimming value status of the actuator is requested immediately (the actuator is indeed set to a dimming value) and the process then continues as described above.</p> <p>If the actuator's dimming value status cannot be received (because the object, for example, is not linked to a group address), then the controller always begins its control at a dimming value of 0%. In the case of lights already switched on, this can cause a transient response resulting in the dimming value required for the lighting. The function of the brightness controller, however, is not affected by this.</p>	

07 B0 KNX / DALI Gateway Twin N 141/31 983D11
 07 B0 KNX / DALI Gateway Twin plus N 141/21 983411
 07 B0 KNX / DALI Gateway plus N 141/03 983711

Scenes which deactivate the controller [0...64]	1-2-3-4-5-6- ... 64, "- (none)"
Upon receipt of a scene, the controller switches to the "inactive" state if the corresponding scene number is configured. The controller behaves passively in this state. Up to 64 scene numbers ranging from 1 to 64 can be selected in the configuration.	
Maximum dimming increment	1 (0.4%); 3 (1.2%); 4 (1.6%); 5 (2.0%); 6 (2.4%), 7 (2.7%); 10 (3.9%)
This parameter is used to define the maximum allowable size of the increment when the variable is output. <u>Note:</u> The increment should be selected in a way that a change in the dimming value no longer changes the lighting strength by more than the set target value hysteresis.	
First dimming value, when the controller starts	Adopt from the parameter Calculate starting value Use last received value
This parameter is used to define how the first dimming value (starting value) of the controller is determined. <u>"Calculate starting value":</u> The current actual value is measured here before the control process starts. This value represents the mixed lighting (artificial lamp lighting plus natural light from outdoors). The measured value of the room brightness is then converted by means of the characteristic curve and used as a starting value for the controller. <u>"adopt from the parameter":</u> This setting is practical when the other option is not feasible <u>"use last received value":</u> This setting uses the last on the object receive dimming value as the start value when the system starts. If no value is available, the value from the "First dimming value".	
First dimming value [0 ... 100%]	0 – 100%, 50%
Start value for the controller, if no other is available.	
Maximum dimming value [0 ... 100%]	1 – 100%, 100%
This parameter defines the maximum dimming value of the master.	
Minimum dimming value [0 ... 100%]	0 – 100%, 0%
This parameter defines the minimum dimming value of the master.	
Constant lighting control	
Name (25 characters)	
Sub groups	
Parameters	Settings
Number of subgroups	0 – 4, 4
This parameter defines the number of subgroups. 0 = no subgroups available	

07 B0 KNX / DALI Gateway Twin N 141/31 983D11
 07 B0 KNX / DALI Gateway Twin plus N 141/21 983411
 07 B0 KNX / DALI Gateway plus N 141/03 983711

Type of calculation	calculate with characteristic curve calculate with offset
<p>This parameter is only visible when the number of subgroups is configured as > 0. This parameter determines which type of computation is used for the dimming variables of lighting subgroups.</p> <p>"Calculate with characteristic curve": The dimming variables for the lighting subgroups are derived from the dimming variable of the main lighting group via calibration curves, which convert the measured (main) lighting strength into a calculated lighting strength at the position of every lighting subgroup.</p> <p>"Calculate with offset": The dimming variables for the lighting subgroups are derived from the dimming variable of the main lighting group or via an offset, which is entered for every lighting subgroup.</p>	
Constant lighting control	
Name (25 characters)	
Sub groups 1 (2, 3, 4)	
Parameters	Settings
Maximum dimming value [0 ... 100%]	1 – 100%, 100%
This parameter is used to define the maximum dimming value of the subgroup (1 - 4).	
Minimum dimming value [0 ... 100%]	0 – 100%, 0%
This parameter is used to define the minimum dimming value of the subgroup (1 - 4).	
Offset for the dimming value of the main group (-100% ... 100%)	0%
This parameter is used to define the dimming value offset of the subgroup (1 - 4) from the main group.	

Constant lighting control	
Name (25 characters)	
Calibration	
Parameters	Settings
Main group	at Position A at Position B at Position C at Position D at Position E
<p>This parameter determines the position (A – E) at which the main lighting group is located. The selection options vary, depending on which value the "Number of subgroups" parameter was set to. If, for example, the "Number of subgroups" was set to 2, then solely the positions A – C are available.</p>	
Measured brightness value of Position A (B,C,D,E) [0...2000 Lux]	0 – 2000, 0
The brightness value measured with a Lux meter at the main lighting group position A (B, C, D, E) in a range of 0 – 2000 Lux is entered here.	
Time until the next value [s]	10 - 60, 12
<p>This parameter is used to define the time between the controller's individual brightness measurements during the automatic calibration.</p> <p><u>Note:</u> A high value should be selected for lights requiring a longer warm-up to reach the full lighting strength.</p>	

07 B0 KNX / DALI Gateway Twin N 141/31 983D11
 07 B0 KNX / DALI Gateway Twin plus N 141/21 983411
 07 B0 KNX / DALI Gateway plus N 141/03 983711

16.5 Objects

Object name	Function	Type	Flag
[Name], Actual value input	Brightness (Lux)	2 byte 9.004	CRW
This communication object is used to receive the brightness value from the sensor in Lux.			
[Name], controller	On/Off	1 bit 1.001	CWT
This object can be used to switch the controller on or off. This information can, for example, come from a button or from the start object of a motion detector. The controller shuts off when a logical "0" is received, i.e. no comparisons are made between the target value and actual value and thus no constant lighting control exists. The "0" variable is sent when the controller is shut off. The controller is switched on when a logical "1" is received. When the bus voltage is restored, the controller is set to "Off". This occurs independently of the controller status which existed at the time of the bus voltage failure.			
[Name], controller status	On/Off	1 bit 1.001	CRT
The controller uses this object to report its internal status. The "On" status means that the controller is either in the "active" state or in the "stand-by" state. The "Off" status means that the controller is either in the "inactive" state or in the "off" state. This object's description has no effect.			
[Name], target value - absolute	Brightness (Lux)	2 Byte 9.004	CRWT
This object is used to set the target value for the constant light controller. Until the first incoming value, the value of the "Maximum target value in Lux" parameter is used as the default value. Note 1: The currently valid controller target value is sent to the bus when a change is made by this object so that a visualization can display this current value. Note 2: If a change occurs in the target value, a controller process can result, depending on the determined value, if the actual value already lies within the hysteresis range around the new target value. Note 3: This object's value is sent automatically when the bus voltage is restored. Note 4: The target value is limited by the minimum / maximum target value parameter settings. Note 5: The target value does not change when a 0 is received.			
[Name], target value - relative	brighter/darker	4 bit 3.007	CRW
This object can be used to change the target value. In this process, the controller increments or decrements the internal value every second by one dimming step set by the parameter if dimming with stop telegram is used. Note 1: The controller can only process changes in the target value every second. If two "¼ dim brighter" telegrams, for example, are received within 200ms, then both will be consolidated. This corresponds to a brighter dimming of 56%. Note 2: The target value is limited by the minimum / maximum target value parameter settings.			
[Name], save target value	1 = Save	1 bit 1.001	CWT
If a value is received via this object, then the brightness value set by the controller is adopted as a new target value. The brightness values of the dimmers are not read in this process. <u>Note:</u> The target value is limited by the minimum / maximum target value parameter settings.			
[Name], Stop	Switching	1 bit 1.001	CWT
If a value is received via this object, then the controller switches to the "inactive" state. The controller behaves passively in this state. This means that although it is virtually still switched on, it no longer performs any kind of control activities.			

07 BO KNX / DALI Gateway Twin N 141/31 983D11
 07 BO KNX / DALI Gateway Twin plus N 141/21 983411
 07 BO KNX / DALI Gateway plus N 141/03 983711

[Name], Stop	Dim	4 bit 3.007	CWT
If a value is received via this object, then the controller switches to the "inactive" state. The controller behaves passively in this state. This means that although it is virtually still switched on, it no longer performs any kind of control activities.			
[Name], Stop	Dimming value	1 byte	CWT
If a value is received via this object, then the controller switches to the "inactive" state. The controller behaves passively in this state. This means that although it is virtually still switched on, it no longer performs any kind of control activities.			
[Name], Stop	Scene	1 Byte 17.001	CWT
Upon receipt of a scene, the controller switches to the "inactive" state if the corresponding scene number is configured. The controller behaves passively in this state. This means that although it is still switched on, it does not perform any kind of control activities.			
[Name], Main group switching	On/Off	1 bit 1.001	CWT
The controller uses this object to send switch-on and shut-off commands for the main lighting group. It sends the "On" value, if the brightness is below the defined brightness value in a given period. If sends the "Off" value if the controller has received a logical "0" or if the controller changes from the "active" status to the "standby" status.			
[Name], Main group dimming value	8-bit value	1 Byte 5.001	CWTU
The controller uses this object to send the dimming values for the main lighting group.			
[Name], Main group dimming value status	8-bit value	1 Byte 5.001	CWTU
This object can be used to query the current dimming value of the dimming actuator of the main lighting group.			
[Name], Subgroup [x] switching	On/Off	1 bit 1.001	CWT
The controller uses this object to send switch-on and shut-off commands for the lighting subgroups. It sends the "On" value if the brightness is below the defined brightness value in a given period. It sends the "Off" value if the controller has received a logical "0" via the object or if the controller variable has reached the specified minimum and, at the same time, the actual brightness value is greater than the target brightness value.			
[Name], Subgroup [x] dimming value	8-bit value	1 Byte 5.001	CWT
The controller uses this object to send the dimming values for the lighting subgroups.			
[Name], Calibration	1=Start	1 bit 1.010	CWT
This object is used to start the controller calibration process with a logical "1". The controller goes into the "inactive" state at the end of the calibration. This object is used to stop the controller calibration process with a logical "0". Note: The actuators are dimmed to 50% upon successful calibration. The actuators are dimmed to the minimum dimming value if the calibration fails.			
[Name], Diagnostic values	Brightness (Lux)	2 Byte 9.004	KÜ
Upon completion of the calibration process started by the "Calibration" object, this object is used to send the 15 determined brightness values. These values are used solely for diagnostic purposes.			

16.6 Behavior during emergency mode

The controller is switched off if emergency mode is received via the general emergency mode object. It then behaves as if the controller was switched off by the "Controller" object. No additional objects are sent. If emergency mode is cancelled again, then this corresponds to switching on the controller.

07 B0 KNX / DALI Gateway Twin N 141/31 983D11
 07 B0 KNX / DALI Gateway Twin plus N 141/21 983411
 07 B0 KNX / DALI Gateway plus N 141/03 983711

17. Timer function

The gateway has a timer function with the following switching points:

- Daily switching times
- Weekly switching times
- Date switching times
- Switching times relative to the sunset or sunrise

Every switching point can be assigned to one of 10 channels.

One disable object per channel is provided for disabling the channels.

A maximum of 2000 switching points (timer actions) can be defined.

The following commands in the menu bar can be used to select the parameter windows.

Parameters window menu	
New	A new line is added.
Delete	The marked line is deleted.
Copy	The marked line is copied to the clipboard.
Paste	The line from the clipboard is added as a new line.

17.1 Location and real time clock (RTC)

The gateway contains an internal real-time clock. It is recommended that the time and date be synchronized daily by the object provided.

Switching time	
Location	
Parameter	Settings
Time-date object type	8-Byte time (19.001 DPT-Date Time) 3-Byte time and date
This parameter can be used to set whether the synchronization is achieved by the new 8-byte object or by the two 3-byte objects.	

The gateway can receive time and date via the following objects:

Object name	Function	Type	Flag
Time	receive	3 byte 10.001	CRWU
This object is used to receive the current time value.			
Date	receive	3 byte 11.001	CRWU
This object is used to receive the current date value.			
Date / Time	receive	8 byte 19.001	CRWU
This object is used to receive the current date and time value.			

Since the UTC format is generally required for the internal clock to calculate the sunrise and sunset times while the time received via the objects corresponds to the local time, both the time zone and the summer and winter times must be set.

The geographical location of the current site is also required to calculate the sunrise and sunset times.

The rule for summer/wintertime is used solely for computing the sunrise/sunset times.

The most important cities from certain countries can be selected in the "location" parameters window for easy configuration.

In addition to this, all of the settings can also be made individually.

07 B0 KNX / DALI Gateway Twin N 141/31 983D11
 07 B0 KNX / DALI Gateway Twin plus N 141/21 983411
 07 B0 KNX / DALI Gateway plus N 141/03 983711

Switching time	
Location	
Parameters	Settings
Country	other Germany ... (additional countries)
This parameter is used to select the country. The following parameters are automatically adapted, depending on the selected country.	
Time zone	Standard specific
This parameter is visible only if the previous "Country" parameter is not set to "other". This parameter is used to set whether the summer/wintertime conversion of the selected country corresponds to the local standard or deviates from it (is specific) and must therefore be set separately.	
Time difference from GMT	-12:00 ... +12:00 00:00
This parameter can only be changed if the previous "Country" parameter is set to "other countries" or "time zone" to "specific". It is otherwise a pure display field. Specifies the number of hours and minutes by which the local wintertime deviates from the GMT.	
Start of summertime (day)	First ... Fourth Last
This parameter can only be changed if the previous "Country" parameter is set to "other" or "time zone" to "specific". It is otherwise a pure display field. Specifies the day of the conversion along with additional parameters.	
Start of summertime (weekday)	Sunday ... Saturday
This parameter can only be changed if the previous "Country" parameter is set to "other" or "time zone" to "specific". It is otherwise a pure display field. Specifies the day of the conversion along with additional parameters.	
Start of summertime (month)	January ... December
This parameter can only be changed if the previous "Country" parameter is set to "other" or "time zone" to "specific". It is otherwise a pure display field. Specifies the day of the conversion along with additional parameters.	
Start of summertime (time)	0:00...11:59 2:00
This parameter can only be changed if the previous "Country" parameter is set to "other" or "time zone" to "specific". It is otherwise a pure display field. Specifies the time of the conversion along with additional parameters.	
Difference between summer/wintertime	-12:00 ... +12:00 00:00
This parameter can only be changed if the previous "Country" parameter is set to "other" or "time zone" to "specific". It is otherwise a pure display field. Specifies the number of hours and minutes by which the local summertime deviates from the local wintertime.	
End of summertime (day)	First ... Fourth Last
This parameter can only be changed if the previous "Country" parameter is set to "other" or "time zone" to "specific". It is otherwise a pure display field. Specifies the day of the conversion along with additional parameters.	

07 B0 KNX / DALI Gateway Twin N 141/31 983D11
 07 B0 KNX / DALI Gateway Twin plus N 141/21 983411
 07 B0 KNX / DALI Gateway plus N 141/03 983711

Switching time	
Location	
Parameters	Settings
End of summertime (weekday)	Sunday ... Saturday
This parameter can only be changed if the previous "Country" parameter is set to "other" or "time zone" to "specific". It is otherwise a pure display field. Specifies the day of the conversion along with additional parameters.	
End of summertime (month)	January ... December
This parameter can only be changed if the previous "Country" parameter is set to "other" or "time zone" to "specific". It is otherwise a pure display field. Specifies the day of the conversion along with additional parameters.	
End of summertime (time)	0:00...11:59 PM 03:00
This parameter can only be changed if the previous "Country" parameter is set to "other" or "time zone" to "specific". It is otherwise a pure display field. Specifies the day of the conversion along with additional parameters.	
Location	other (Cities, country-specific)
This parameter is only visible if a country was selected for which one or more cities are offered as options. If this parameter is set to one of the optional cities, then the associated longitude and latitude specifications are set automatically. If none of these cities apply and this parameter is thus set to "other", then the following four parameters are supplemented for the input of the longitude and latitude specifications.	
Longitude [-180° ...+180° O]	-180...+180 0
This parameter is used to set the degree specification for the eastern longitude.	
Longitude [-59'...+59' O]	-59...+59 0
This parameter is used to set the minute specification for the eastern longitude.	
Latitude [-90° ...+90° N]	-180...+180 0
This parameter is used to set the degree specification for the northern latitude.	
Latitude [-59'...+59' N]	-59...+59 0
This parameter is used to set the minute specification for the northern latitude.	

Hints:

Since the time is synchronized by telegrams, time leaps (e.g. 20 years!) may be possible which the internal real time clock cannot intercept. The timer functions supported by the internal real time clock react to this as follows:

The switching points are subsequently executed in accordance with the processes described in Section 0 for all kinds of time leaps into the future.

Small time leaps into the past only have an effect due to a prolonged time span before the next switching points.

If the administration of the timer functions, however, determines a large time leap into the past, then the switching points are reset as of this time. This prevents an excessive waiting time until the next timer action. It can occur in this case that a number of switching points are repeatedly executed.

Polar day/polar night

This function can only be used to a limited degree for locations having northern latitude > 65°.

07 B0 KNX / DALI Gateway Twin N 141/31 983D11
 07 B0 KNX / DALI Gateway Twin plus N 141/21 983411
 07 B0 KNX / DALI Gateway plus N 141/03 983711

17.2 Channels

Channels				
New Delete Copy Paste				
	Nr	Name	Type	Update
▶	1	Channel 1	On / Off ▼	no ▼
	2	Channel 2	Scene	no
	3	Channel 3	Effect	no
	4	Channel 4	Forced control	no
	5	Channel 5	On / Off	no

Fig. 34 Channels parameters window

The following parameters are provided for each channel.

Switching time	
Channels	
Parameters	Settings
Channel (25 characters)	
This parameter can be used to assign each channel a name with a maximum of 25 characters. This name is used for the communication objects belonging to this channel.	
Type	On/Off Scene Effect Priority control Color temperature
Selection of the channel type	
After-run	No Yes Last
This parameter is used to define whether or not this channel will continue to run when the bus voltage is restored following a power failure, i.e. whether or not telegrams cancelled during this time should be subsequently sent. "No" this time command is not considered during the after-run "Yes" the desired telegram is sent every time this channel's missed switching points come up during the after-run. "Last" the last valid value is not sent until the end of the after-run; no intermediate values are sent.	

Depending on the function selection, every channel contains the following objects:

Object name	Function	Type	Flag
[Channel], Switching	On/Off	1 bit 1.001	CRT
[Channel], Scene	Call up	1 byte 17.001	CRT
[Channel], Effect	start/stop	1 byte 18.001	CRT
[Channel], Priority control	On/Off	2 bit 2.001	CRT
[Channel], Disable	1 = disable	1 bit 1.001	CRWT
The channel is disabled and no telegram sent when a "1" is received.			

07 B0 KNX / DALI Gateway Twin N 141/31 983D11
 07 B0 KNX / DALI Gateway Twin plus N 141/21 983411
 07 B0 KNX / DALI Gateway plus N 141/03 983711

17.3 Switching points

The switching points are the timer actions which should be executed at defined points in time.

Timing					
New Delete Copy Paste					
No.	Description	Timing	Channel	Value	Effect start
1	Description 1	Daily at 12:00 PM	Channel 1	Off	
2	Description 2	Daily at 12:00 AM	Channel 2	1	
3	Description 3	Daily at Sunrise	Channel 2	1	
4	Description 4	Daily at 12:00 AM	Channel 3	1	<input checked="" type="checkbox"/>
5	Description 5	Daily at 6:00 AM	Channel 1	Off	
6	Description 6	Daily at 12:00 AM	Channel 1	Off	
7	Description 7	Daily at 11:00 AM	Channel 1	Off	
8	Description 8	Daily at 12:00 AM	Channel 1	Off	

Fig. 35 Switching points parameters window

Switching time	
Timing	
Parameters	Settings
Description	
Each switching point can have an individual description.	
Type	Daily switching time Weekly switching time Date switching time
The type of timer function is defined here.	
Channel	
The corresponding channel can be selected here from the list of configured channels.	
Value	On Off
Only visible when the function of the selected channel is "Switch On/Off". The value to be sent is set here.	
Scene	1...64 1
Only visible when the function of the selected channel is "Scene". The scene to be called up is set here.	
Effect	1...64 1
Only visible when the function of the selected channel is "Effect".	
Start Effect	<input checked="" type="checkbox"/> (start) <input type="checkbox"/> (end)
Only to be processed when the function of the selected channel is "Effect".	
Priority control	Deactivate priority control Priority-controlled OFF Priority-controlled ON
Only visible when the function of the selected channel is "Priority control". The type of priority control status to be sent is set here.	
Value	1000...20000K 1000K
Only visible when the function of the selected channel is "color temperature." The value to be sent is set here.	

Depending on the set types, the following parameters can still be set for every timer action.

07 B0 KNX / DALI Gateway Twin N 141/31 983D11
 07 B0 KNX / DALI Gateway Twin plus N 141/21 983411
 07 B0 KNX / DALI Gateway plus N 141/03 983711

17.3.1 Daily switching time

Parameter	Settings
Timer point	Absolute time Relative to the sunrise Relative to the sunset
Determines the type of timer point.	
Absolute time	0:00...11:59 PM 00:01 AM
Only visible when "Absolute time" is set. Determines the switching time.	
Relative time	-12:00 ... +12:00 00:00 AM
Only visible when "Relative to the sunrise" or "Relative to the sunset" is set. Determines the time difference prior to or after the sunrise or sunset when the switching should occur.	

17.3.2 Weekly switching time

The weekly timer switch contains the same parameters as the daily timer switch with the addition of the following parameters:

Parameter	Settings
Weekdays	<input type="checkbox"/> Sunday <input type="checkbox"/> Monday <input type="checkbox"/> ... <input type="checkbox"/> Saturday
Selection of the weekday or weekdays, when the switching point is executed.	

17.3.3 Date switching time

The date timer switch contains the same parameters as the daily timer switch with the addition of the following parameters:

Parameters	Settings
Day	1...31 1
Determines the day on which the switching should occur. If a day is selected which does not occur in a given month, then the switching point is not executed when the day is passed. Example: 31st day is not executed in February.	
Month (0 = every month)	1...12 0
Determines the month in which the switching should occur. If "0" is set here, the switching will occur every month on the set day. "0" must be set for the year.	
Year (0 = every year)	2010...2089 0
Determines the year in which the switching should occur. If "0" is entered here, switching will occur every time on the set day the month entered.	

07 B0 KNX / DALI Gateway Twin N 141/31 983D11
 07 B0 KNX / DALI Gateway Twin plus N 141/21 983411
 07 B0 KNX / DALI Gateway plus N 141/03 983711

17.4 Behavior during after-run

General parameters can be configured in the "Timer function" parameters window.

Parameters	Settings
Over-run when the bus voltage returns	as of bus voltage failure as of midnight
This parameter specifies whether the time commands should be subsequently processed following (prolonged) bus voltage / mains failure only as of midnight of the current day or from the start of the bus voltage failure.	
Over-run as of time difference > [Minutes]	0-120 0
<p>In general the time commands are subsequently executed at double speed. The parameter specifies in minutes how long the bus must fail before the time commands are subsequently processed at the highest possible speed (more than double). (>: greater than) The timer actions are processed at double speed when the bus voltage failure is shorter than the set value or as soon as the fast subsequent execution has progressed so far that the time deviation is correspondingly short. The actual duration of the over-run depends, however, on the following factors: Total duration of the failure, Number of the switching actions to be subsequently executed as fast as possible and the number of switching actions in the time window of the double speed. Especially for "Over-run = last", these switching points are not sent until the end of the over-run time, whereby the sequence of the configuration is not complied with!</p>	

07 B0 KNX / DALI Gateway Twin N 141/31 983D11
 07 B0 KNX / DALI Gateway Twin plus N 141/21 983411
 07 B0 KNX / DALI Gateway plus N 141/03 983711

18. Failure status devices

18.1 Parameter

General	
Status messages	
Parameter	Settings
DALI, status failure	Send only on read request Send on status change Send on status change/bus voltage recovery
<p>This parameter sets whether the objects "[Channel], DALI device failure", "Voltage failure" and "[Channel], DALI short circuit" should be added.</p> <p>If the parameter setting is "Send on status change", objects are sent automatically on each status change.</p> <p>With "Send on status change/bus voltage recovery", objects are sent on bus voltage recovery and automatically on each status change.</p> <p>Sending is not automatic with "send only on read request".</p> <p>Sending the status via a read request is possible with any parameter setting.</p>	

18.2 Power failure

The 1-bit status object "Power failure" reports the status of the common power supply for the gateway and the DALI line. If the object value = "0", then the power supply is present. If the object value = "1", then the power supply has failed. With this, the gateway is no longer functional and all ECGs enter the configured dimming state for a failure of the DALI -voltage.

A short-term buffer power supply for the gateway -electronics integrated with the device ensures that a mains power failure is detected and the power supply status telegram can still be transferred.

No.	Object name	Function	Type	Flag
34	Power failure	1=mains failure	1 bit	CRT
The power supply status for the gateway N 141/31 and for the DALI -lines (0=no mains failure; 1=mains failure) is sent to this object via the group address.				

07 B0 KNX / DALI Gateway Twin N 141/31 983D11
 07 B0 KNX / DALI Gateway Twin plus N 141/21 983411
 07 B0 KNX / DALI Gateway plus N 141/03 983711

18.3 DALI device failure

The 1-bit object "[Channel], DALI device failure" reports that the power supply to DALI devices must have failed. If more than the number configured with the parameter "Channel [A|B], failure >= DALI device(s)" are no longer responding to queries, a failure of the power supply for the DALI devices is assumed. If the object value = "0", then the power supply is present. If the object value = "1", then the DALI device power supply has failed. A separate object and a separate parameter are available for each DALI channel:

No.	Object name	Function	Type	Flag
30	A, DALI device failure	1=failure	1 bit	CRT
32	B, DALI device failure	1=failure	1 bit	CRT

If polling the DALI devices establishes that the power supply to the DALI devices has failed, the status of the power supply for the DALI devices is sent via this object (0=no failure; 1=failure).

General	
Status messages	
Parameter	Settings
Channel [A B], failure >= DALI device(s)	1-64 1

If the number of DALI devices with a power failure is \geq the configured value, the object "[Channel], DALI device failure" is set to 1 = "failure" or to 0 = "no failure".

18.4 DALI short circuit

The object "[Channel], DALI short circuit" reports a short circuit of the DALI- line. If the object value = "0", then there is no short circuit. If the object value = "1", then the DALI line has short-circuited. The DALI -gateway can no longer control the DALI -devices and all DALI -ECGs enter the dimming state configured for a DALI voltage failure

No.	Object name	Function	Type	Flag
31	A, DALI short circuit	1=short circuit	1 bit	CRT
33	B, DALI short circuit	1=short circuit	1 bit	CRT

A short circuit of the DALI line is reported to this object via the group address (0=no short circuit; 1=short circuit).

07 B0 KNX / DALI Gateway Twin N 141/31 983D11 07 B0 KNX / DALI Gateway Twin plus N 141/21 983411 07 B0 KNX / DALI Gateway plus N 141/03 983711
--

19. Export/Import/Convert

19.1 Overview

All plug-in settings and data can be saved via an XML file to another storage location (e.g. hard disk). This can be useful if a configuration is to be transferred to another device or provided as a template.

Note: This XML file must not be changed manually; for this, the content is checked for data consistency with a checksum.

The XML file can be generated from the plug-in via "Export" and read in with "Import". All settings are overwritten on import.

19.2 Export

The export mechanism backs up a KNX/DALI gateway's settings in a file. In addition to all descriptions, settings, plug-in parameters, the DALI device numbers and names assigned on commissioning are also exported in this file. These exported numbers, names and group assignments, however, are valid only while no fresh ECGs are initialized and no other application have been loaded into the device from the associated gateway.

19.3 Import

This function imports exported configuration data (XML file) from other gateways. Files with identical version numbers can be imported directly.

XML files from other gateway versions can be imported only by using an installed KNX converter library.

19.4 KNX converter library

This KNX converter library is the basis for all existing conversions of GAMMA devices. Possible conversions are calculated automatically. Updates are via the "Software Manager".

If the KNX converter library is not installed, this note pops up in the import dialog:

"Converter not found! Click the download button to download the converter setup from a Siemens internet page.

A configuration file with the current application number can be imported directly.

Note: The KNX converter library includes all available current conversions. Together with the converter library, the "Software Manager" is installed, which notifies new versions that can then be installed with ease.

For the software installation, the ETS should be closed and restarted after installation is complete.

07 BO KNX / DALI Gateway Twin N 141/31 983D11
 07 BO KNX / DALI Gateway Twin plus N 141/21 983411
 07 BO KNX / DALI Gateway plus N 141/03 983711

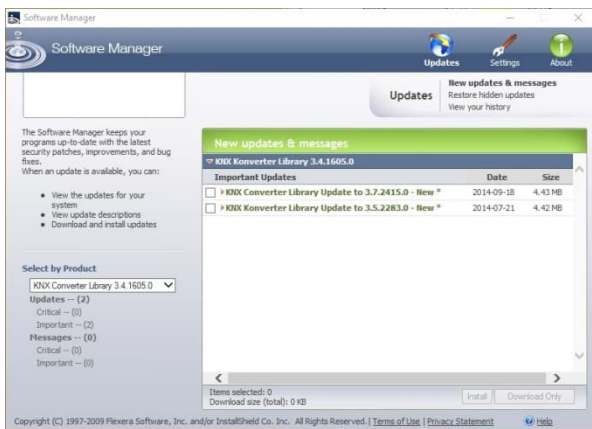

The Software Manager can be called up manually and configured via the Start menu. In addition, updates are reported via a service in the status bar.

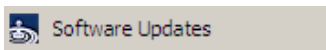

More information:
<http://www.siemens.com/gamma-converter>

19.5 GAMMA Converter App

An ETS App "GAMMA Converter App" is provided for replacing devices in ETS projects. This app is particularly recommended when a large number of devices need to be replaced (large-scale operations). The ETS App can be purchased from the KNX Online Shop.

More information: www.knx.org

07 B0 KNX / DALI Gateway Twin N 141/31 983D11
 07 B0 KNX / DALI Gateway Twin plus N 141/21 983411
 07 B0 KNX / DALI Gateway plus N 141/03 983711

20. Documentation

The application program prints out the entire gateway configuration. Use File - Preview to show the generated document in a preview presentation. Print prints out the document immediately.

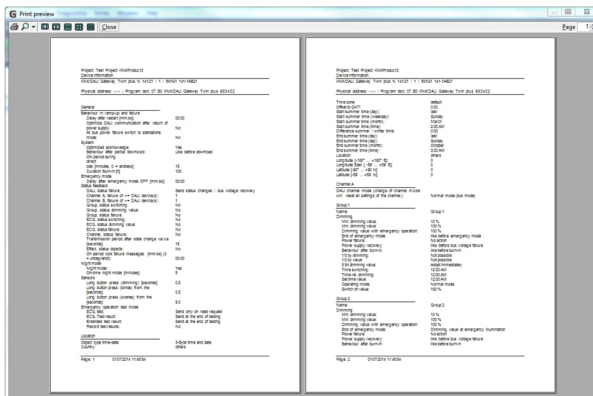

Fig. 36 Print preview

Note: The print preview is only shown in German if the corresponding .net Frameworks language pack is installed.

07 B0 KNX / DALI Gateway Twin N 141/31 983D11
 07 B0 KNX / DALI Gateway Twin plus N 141/21 983411
 07 B0 KNX / DALI Gateway plus N 141/03 983711

21. Commissioning

Commissioning assigns defined DALI subscribers to the actual DALI devices in the system. A unique abbreviated address is assigned to every DALI subscriber (ECG, sensor, etc.). This assignment is unnecessary in "Broadcast" channel mode.

The general features are described with the ECG, in which the commissioning functionality applies also for sensors.



Fig. 37 ECG start-up parameters window

- (1) ECG list
- (2) Assignment
- (3) Placeholder
- (4) Search result

21.1.1 General

The following criteria are necessary for commissioning the gateway:

- a) All DALI devices supplied with power: Gateway, ECG, etc.
- b) All DALI subscribers (ECGs, sensors, etc.) are connected with the gateway
- c) KNX connection via the interface guaranteed
- d) Physical address of the gateway programmed

Note: A download must generally be performed following adaptations during start-up.

21.1.2 Status line

The plug-in distinguishes between two modes:

- Offline: no connection to the gateway
- Online: Connection established to the gateway

Certain functions (commissioning, testing, etc.) function only "online".

The current connection status is shown in the status line. A connection trial can be controlled accordingly through the two buttons - "Reconnect" and "Cancel". On successful setup of the connection, the current firmware versions are shown.

If the connection cannot be set up, this is indicated by "Failure".

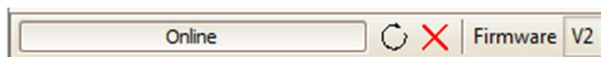

Fig. 38 Status line

21.1.3 Editing the ECG list

The following columns can be directly edited if no ECG is assigned.

- ECG name
- Group
- Device type
- Emergency lighting type (if device type 1)

07 B0 KNX / DALI Gateway Twin N 141/31 983D11
 07 B0 KNX / DALI Gateway Twin plus N 141/21 983411
 07 B0 KNX / DALI Gateway plus N 141/03 983711

21.1.4 Assign

The assignment can take the following forms:

- Buttons: DALI devices can be assigned with both buttons between the ECG list and the search result. The type of assignment is shown by the direction of the arrow.
- Drag & Drop: Lines in either list can be assigned to the other list by means of "drag and drop".
- Double clicking: Double clicking on an unassigned ECG assigns the marked ECG from the search result.
- CIN: If at least one CIN is configured in the ECG parameter sets, then an attempt will be made to automatically assign all of the ECGs having a configured CIN before the user can make the assignments manually.
- In the case of emergency lights that belong together, they can also be connected manually in the right window (Search) during commissioning:

Short address	Device type	Dummy	Error	Linked dev...	Random address
0x8 (8) 1		<input type="checkbox"/>	<input type="checkbox"/>		- 25 E7 D2
0x9 (9) 0		<input type="checkbox"/>	<input type="checkbox"/>		- 28 AC 8E
0xa (10) 0		<input type="checkbox"/>	<input type="checkbox"/>		- 28 B1 F7
0xb (11) 0		<input type="checkbox"/>	<input type="checkbox"/>		- 29 7B CC
0xc (12) 0		<input type="checkbox"/>	<input type="checkbox"/>		- 2A 23 68
0xd (13) 0		<input type="checkbox"/>	<input type="checkbox"/>		- 2A A9 1D
0xe (14) 0		<input type="checkbox"/>	<input type="checkbox"/>		- 2C 85 4B
0xf (15) 0		<input type="checkbox"/>	<input type="checkbox"/>		- 2D CE 91
0x10 (16) 0		<input type="checkbox"/>	<input type="checkbox"/>		- 32 51 38
0x11 (17) 0		<input type="checkbox"/>	<input type="checkbox"/>		- 32 C4 03
0x12 (18) 0		<input type="checkbox"/>	<input type="checkbox"/>		- 38 0E A3
0x13 (19) 0		<input type="checkbox"/>	<input type="checkbox"/>		- 3D 68 93
0x14 (20) 0		<input type="checkbox"/>	<input type="checkbox"/>		- 43 52 45
0x15 (21) 0		<input type="checkbox"/>	<input type="checkbox"/>		- 43 8E B1
0x16 (22) 0		<input type="checkbox"/>	<input type="checkbox"/>		- 4E 46 E6
0x17 (23) 0		<input type="checkbox"/>	<input type="checkbox"/>		- 4F D5 E7
0x35 (53) 0		<input type="checkbox"/>	<input type="checkbox"/>		- 54 6A A6
0x54 (86) 0		<input type="checkbox"/>	<input type="checkbox"/>		- 57 54 21

Context menu for 0x8 (8):
 Connect with ... →
 Disconnect

Before a manual connection can be made, the short address of the ECG and the corresponding converter must be known!

- 1.- Select the ECG in the right half of the window
- 2.- Click on "Connect to ..." from the context menu associated with the ECG. The short addresses of all converters not yet connected are displayed
- 3.- Select the short address of the converter you want to connect to the ECG. After selecting and marking the short address the converter and ECG will be automatically connected
- 4.- The combination of ECG and converter can then be assigned to a parameterized ECG

The assignment can only be completed if the following conditions apply:

- The configured device type and the device type of the found device must be the same.
- For devices with a number of device types, all device types known to the plug-in must be the same.
- If the configured device type and the device type of the found device do not match is a note as to whether this should be automatically adjusted. This information can be displayed via the menu item "Options" from or from being dazzled. If no device type is configured, then solely unknown device types can be assigned to the device: e.g. for device type 8. Without a device type, the basic switching and dimming functions are supported.
- The set minimum value must be \geq the minimum physical dimming value. If this is not the case, this will be adjusted on demand automatically.
- In the case of single battery emergency lights, the emergency light type (with 1 DALI devices/with 2 DALI devices) must match.

The list of all ECGs found is determined by an automatic search algorithm. In the case of single battery emergency lights, the type involved is automatically detected. All of the required information is also read out from the ECG.

07 B0 KNX / DALI Gateway Twin N 141/31 983D11
 07 B0 KNX / DALI Gateway Twin plus N 141/21 983411
 07 B0 KNX / DALI Gateway plus N 141/03 983711

21.1.5 Commissioning - ECG

Button

Commissioning mode	automatic Flashing Shut-down Switch-on Function test
--------------------	---

This parameter decides how an individual DALI device can be identified: "automatically" (by flashing or switching off, depending on the detected lighting type, which is connected to the DALI device; by switching off or on with HQL lamps), by "flashing", by "switching off" or by "switching on" the lighting connected to the DALI device.

The flashing (blinking) interval can be individually in the menu "Options". In the case of single battery emergency lights "Function test" appears as an additional optional parameter. If this parameter setting is selected, then the status-LED for the battery display blinks during the converter start-up. At the same time, the connected ECG normally takes on a different dimming value.

All ECGs ON
 All ECGs connected to the gateway are switched on at maximum brightness.

All ECGs OFF
 All ECGs connected to the gateway are switched off.

Swap short address
 The assigned short addresses can be changed.

In the dialog, the currently selected short address as "old short address". The user can select the desired address as "New short address" entries and the application tries to the two short addresses to replace.

In the dialog is "the new short address" as decimal number in the range 0 to 63 must be entered. The displays of the short addresses are combined hexadecimal and decimal in brackets. The replacement is started with "Execute".

In the example the two short addresses 7 and 3 replaced.

Before:

No.	Name	Group	Short address	Device type	Assigned	Error
1	ECG 1	Group 1	0x7 (7)	0	<input checked="" type="checkbox"/>	<input type="checkbox"/>
2	ECG 2	Group 1	0x2 (2)	0	<input checked="" type="checkbox"/>	<input type="checkbox"/>
3	ECG 3	(none)	0xd (13)	0	<input checked="" type="checkbox"/>	<input type="checkbox"/>
4	ECG 4	(none)	-	0	<input type="checkbox"/>	<input type="checkbox"/>
5	ECG 5	(none)	-	0	<input type="checkbox"/>	<input type="checkbox"/>

After:

No.	Name	Group	Short address	Device type	Assigned	Error
1	ECG 1	Group 1	0x3 (3)	0	<input checked="" type="checkbox"/>	<input type="checkbox"/>
2	ECG 2	Group 1	0x2 (2)	0	<input checked="" type="checkbox"/>	<input type="checkbox"/>

Add automatically

07 B0 KNX / DALI Gateway Twin N 141/31 983D11
 07 B0 KNX / DALI Gateway Twin plus N 141/21 983411
 07 B0 KNX / DALI Gateway plus N 141/03 983711

Button
<p>Found and not yet assigned ECG after selecting this function will be automatically created as ECG. what its actuation for unassigned ECGS creates a new parameter entry and the ECG is this assigns. Requirements: The user starts the commissioning and searches for ECG. It will not be assigned ECG found. In the case of N 141/31 (983x06) must be at least one group. There must be at least the number of found unassigned ECGS can be added.</p>
<- ECG - assign
<p>The configured and actual ECG is chosen by selecting the desired ECG on the left or right side and clicking on the ← button. It is also possible to execute the assignment by double clicking on one of the two ECGs selected. This button is only released if compatible inputs are selected on both sides.</p>
-> ECG - delete assignment
<p>This function transfers a previously assigned ECG again to the right field as an unassigned ECG. With a subsequent parameter download in the gateway, a real ECG is no longer assigned to this configured ECG. This process can also remove an ECG marked as defective. A new ECG can be assigned in this way (ECG exchange). This button is only released if an assigned ECG is selected on the left side.</p>

21.1.5.1 ECG list

Button
Edit (right click in the line)
<p>Right-clicking in an ECG table line switches you into the corresponding ECG parameter window. Name and group assignment can be edited and the device assignment deleted if need be. If the ECG is still unassigned, the device type can be edited.</p>
Assigned
<p>This indicates a successful assignment. Use Edit to delete the assignment</p>
Failure
<p>If the assignment could not be completed successfully, a failure is indicated here. At the same time, the line is shown in red. Note: A failure flag is only set if the data stored in the plug-in no longer correspond to the ECG data from a new search process. This means that the ECG is no longer available or was replaced.</p>

07 B0 KNX / DALI Gateway Twin N 141/31 983D11 07 B0 KNX / DALI Gateway Twin plus N 141/21 983411 07 B0 KNX / DALI Gateway plus N 141/03 983711
--

21.1.5.2 Search ECG

Button
<p>ECG Search</p> <p>Pressing this button searches for all serviceable DALI devices connected to the gateway. A search begins which lasts for a few minutes. The DALI devices that are found appear for the first time in the right-hand list with the headings "Short address" and "Device type". Previously assigned ECGs have the same value in the relevant "Short address" column. No short address "-" appears for a DALI device shown in the left-hand window to which no device found has been assigned. This search must also be performed whenever DALI devices are exchanged or added.</p> <p>Further searches can follow the first if, say, further DALI devices are installed or exchanged. It may be that DALI devices found previously on commissioning are no longer connected to the power supply in a further search. This is indicated by <input checked="" type="checkbox"/> in the "Failure" column. The table can be sorted by any column, so that defective DALI devices can be checked very easily. In a fresh search, defective DALI devices, if they are again serviceable, are also indicated again as having no failures <input type="checkbox"/>.</p> <p><i>Note: Before searching for DALI devices, all installed DALI devices should be connected with the gateway and be ready for operation.</i></p> <p><i>Note: DALI devices that support a number of DALI device types appear in the search result with all types by which they are supported separated by a comma (e.g.: 0,2,3,4).</i></p> <p><i>Note: When addressing conflicts should not be automatically corrected (e.g. double long addresses and short addresses), "Settings" - "Current Settings Reset Reset all links". By means of a new search in the short and long addresses of the conflict to be re-assigned.</i></p>
<p>Initialize (reset) – Selected ECG / all ECGs</p> <p>All ECGs or all selected ECGs will be reset or initialized.</p> <p>After the reset, a search process must be restarted.</p> <p>Application 1: During commissioning, the system dictates that two ECGs shall flash. "Initialize" resolves this conflict.</p> <p>Application 2: An ECG is reset after "Initializing" and can be connected in another DALI system without any problems. Only in this way is an address conflict avoided.</p>

21.1.5.3 Placeholder

Placeholders are used to determine short addresses for DALI devices

- which cannot be assigned the short address via the plug-in (coding switch on the ECG) and
- for short address assignment via an external tool.

Note: These ECGs must be connected to the DALI bus in a serviceable state in the event of a search.

The "New placeholder" button can add a placeholder (incl. device type) and assign it to an ECG. A search should always be made so that the updated information is available to the plug-in.

Note:

"Delete" deletes an ECG placeholder again.

The "Placeholder" column shows whether an ECG has been added as a placeholder. If an ECG with the address of a placeholder is found in the search, then it is replaced by the ECG.

07 B0 KNX / DALI Gateway Twin N 141/31 983D11
 07 B0 KNX / DALI Gateway Twin plus N 141/21 983411
 07 B0 KNX / DALI Gateway plus N 141/03 983711

21.1.6 Commissioning - Sensors

Sensors are commissioned in the same way as an ECG. However, no placeholder is provided.

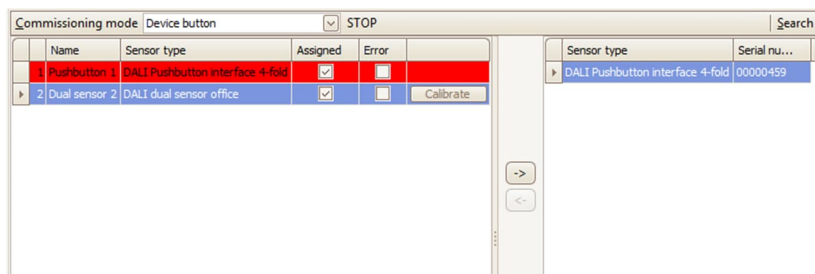

Fig. 39 Sensor start-up parameters window

Button	
Commissioning mode	Device button
	Device LED
<p>This parameter decides how an individual DALI sensor can be identified: "Device button": START enables detection mode. The plug-in detects pressing of the button or an operation of a button interface input channel by means of the device serial number communicated and marks the corresponding line in red (→ Fig. 40). Detection mode can be disabled with STOP.</p> <p>"Device LED": The device LED for the device marked in the search result is enabled.</p> <p>The precise position of the device button or of the device LED should be taken from the DALI sensor documentation.</p>	
START - STOP	
<p>START starts detection mode for the "Device button" commissioning mode. START and STOP are visible only in "Device button" mode</p>	
<- Sensor - assign	
<p>The configured and actual Sensor is chosen by selecting the desired Sensor on the left or right side and clicking on the <- button.</p> <p>It is also possible to execute the assignment by double clicking on one of the two Sensors selected. This button is only released if compatible inputs are selected on both sides.</p>	
-> Sensor - delete assignment	
<p>This function transfers a previously assigned Sensor again to the right field as an unassigned Sensor. With a subsequent parameter download in the gateway, a real Sensor is no longer assigned to this configured Sensor. This process can also remove an Sensor marked as defective. A new Sensor can be assigned in this way (Sensorchange). This button is only released if an assigned Sensor is selected on the left side.</p>	
Search	
<p>Pressing this button searches for all serviceable DALI sensors connected to the gateway. A search begins which lasts for a few minutes. The DALI sensors found appear as a search result with the headings "Device type" and "Serial number". Previously assigned sensors have the same value in the relevant "Short address" column. No short address "-" appears for devices shown in the sensor list, for which no device found has been assigned.</p> <p>This search must also be performed whenever DALI devices are exchanged or added.</p> <p>Further searches can follow the first if, say, further DALI sensors are installed or exchanged. Defective sensors are indicated by <input checked="" type="checkbox"/> in the "Failure" column. The sensor list can be sorted by any column, so that defective DALI sensors can be checked very easily. In a fresh search, defective DALI devices, if they are again serviceable, are also indicated again as having no failures "<input type="checkbox"/>".</p> <p><u>Note:</u> Before searching for DALI devices, all installed DALI devices should be connected with the gateway and be ready for operation. Only the sensor types available in the plug-in can be assigned.</p>	
Edit (right click in the line)	
<p>Right-clicking in an Sensor table line switches you into the corresponding Sensor parameter window. Name and group assignment can be edited and the device assignment deleted if need be. If the Sensor is still unassigned, the device type can be edited.</p>	

07 B0 KNX / DALI Gateway Twin N 141/31 983D11
 07 B0 KNX / DALI Gateway Twin plus N 141/21 983411
 07 B0 KNX / DALI Gateway plus N 141/03 983711

Button

Assigned

This indicates a successful assignment. Use Edit to delete the assignment

Failure

If the assignment could not be completed successfully, a failure is indicated here. A failure is displayed here if the sensor can no longer be found after a new search or if the data do not match.

Calibrate

This button is only visible in DALI sensors with brightness sensor. It matches the brightness sensor to the installation situation and the ambient degree of reflection.

The real "value measured" in Lux with a brightness measurement device is entered in the field. The correction factor is calculated automatically and shown in the "Adjustment factor" field. The measured raw value is shown for information. The correction factor is transferred to the parameters page (→ 11.4.2).

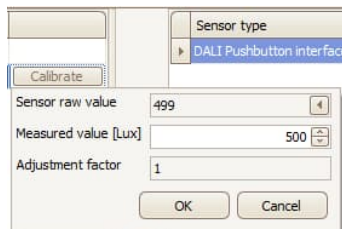

Fig. 40 Brightness sensor calibration

07 B0 KNX / DALI Gateway Twin N 141/31 983D11
 07 B0 KNX / DALI Gateway Twin plus N 141/21 983411
 07 B0 KNX / DALI Gateway plus N 141/03 983711

22. Test

Individual ECGs and groups can be switched directly after commissioning for testing, or dimmed to a variable value without any need for this to be sent via group address telegrams.

22.1 Groups

All ON		All OFF											
No.	Name	Address	Min. dimming value	Max. dimming value	Switch on value	Current value	I	O	+	-	✓	R	
1	Group 1	0x0	1 %	100 %	100 %	100 %	?	I	O	+	-	✓	R
2	Group 2	0x1	1 %	100 %	100 %	20 %	?	I	O	+	-	✓	R
3	Group 3	0x2	10 %	100 %	100 %	100 %	?	I	O	+	-	✓	R
4	Group 4	0x3	1 %	100 %	100 %	20 %	?	I	O	+	-	✓	R
5	Group 5	0x4	1 %	100 %	100 %	100 %	?	I	O	+	-	✓	R
6	Group 6	0x5	10 %	100 %	100 %	100 %	?	I	O	+	-	✓	R
7	Group 7	0x6	1 %	100 %	100 %	100 %	?	I	O	+	-	✓	R
8	Group 8	0x7	10 %	100 %	100 %	100 %	?	I	O	+	-	✓	R
9	Group 9	0x8	10 %	100 %	100 %	100 %	?	I	O	+	-	✓	R
10	Group 10	0x9	1 %	100 %	100 %	20 %	?	I	O	+	-	✓	R
11	Group 11	0xa	1 %	100 %	100 %	20 %	?	I	O	+	-	✓	R
12	Group 12	0xb	10 %	100 %	100 %	100 %	?	I	O	+	-	✓	R
13	Group 13	0xc	1 %	100 %	100 %	100 %	?	I	O	+	-	✓	R
14	Group 14	0xd	1 %	100 %	100 %	20 %	?	I	O	+	-	✓	R
15	Group 15	0xe	1 %	100 %	100 %	20 %	?	I	O	+	-	✓	R
16	Group 16	0xf	1 %	100 %	100 %	100 %	?	I	O	+	-	✓	R

Note: download of current configuration necessary.

Fig. 41 Group test parameters window

Individual groups are listed with their parameters.

Use the buttons to test the group function.



The behavior of the group for the functions specified above corresponds to a receipt on the corresponding communication objects: On/Off switching, brighter/darker dimming, set dimming value, and set color temperature value. Previously set dimming times are ignored. The time function is also disabled. Again, no group addresses should be assigned for the test.

These buttons can be used to execute the following functions for the dimming behavior.

Button
All groups ON
This button switches on all groups.
All groups OFF
This button switches off all groups.
Read status values
With this button, all status values are read.
(On)
Use this button to switch on the group.
(Off)
Use this button to switch off the group.
Use these buttons to brighten/darken the switched on group incrementally by approx. 1/20 (5%). Is switched off using the button . It shall be subject to the limits for min/max. Dimming values.
Set value
Enter the value and click on the button to send the dimming value to the group.
? (Entry/display field)
This field shows the current dimming value [%], after the "Read value" button was pressed. You can also enter a dimming value [%] here and send it with the "Set value" button.
Read value
This button forces reading of the current dimming value of the selected group.

07 B0 KNX / DALI Gateway Twin N 141/31 983D11
 07 B0 KNX / DALI Gateway Twin plus N 141/21 983411
 07 B0 KNX / DALI Gateway plus N 141/03 983711

These buttons can be used to execute the following additional functions for the color temperature.

Button	
	This button can be used to dim the color temperature of the group warmer/colder in 200K steps. The limits for min./max. color temperature values apply.
<input checked="" type="checkbox"/> Set value	Enter the value and click on the button to send the color temperature value to the group.
? (Entry/display field)	This field shows the current color temperature value [K], after using the "Read value" button. You can also enter a color temperature value [K] here and use the "Set value" button to send it.
 Read value	This button triggers reading of the current color temperature value of the selected group.

22.2 ECG

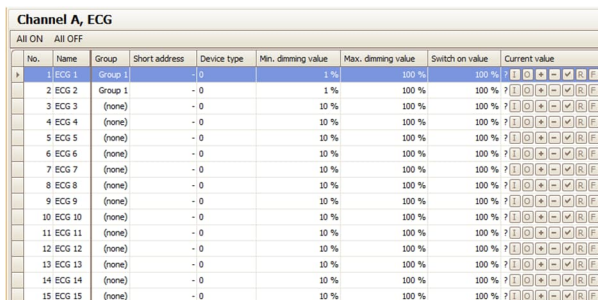



















No.	Name	Group	Short address	Device type	Min. dimming value	Max. dimming value	Switch on value	Current value
1	ECG 1	Group 1	-0		1 %	100 %	100 %	
2	ECG 2	Group 1	-0		1 %	100 %	100 %	
3	ECG 3	(none)	-0		10 %	100 %	100 %	
4	ECG 4	(none)	-0		10 %	100 %	100 %	
5	ECG 5	(none)	-0		10 %	100 %	100 %	
6	ECG 6	(none)	-0		10 %	100 %	100 %	
7	ECG 7	(none)	-0		10 %	100 %	100 %	
8	ECG 8	(none)	-0		10 %	100 %	100 %	
9	ECG 9	(none)	-0		10 %	100 %	100 %	
10	ECG 10	(none)	-0		10 %	100 %	100 %	
11	ECG 11	(none)	-0		10 %	100 %	100 %	
12	ECG 12	(none)	-0		10 %	100 %	100 %	
13	ECG 13	(none)	-0		10 %	100 %	100 %	
14	ECG 14	(none)	-0		10 %	100 %	100 %	
15	ECG 15	(none)	-0		10 %	100 %	100 %	

Fig. 42 ECG test parameters window



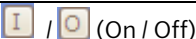

After selecting a list entry, the following functions can be executed via the buttons.

Button	
All ECGs ON	This switches on all connected ECGs.
All ECGs OFF	This switches off all connected ECGs.
 (On / Off)	Both buttons can switch the ECG on or off, even if it is assigned to a group.
<input checked="" type="checkbox"/> Set value	After entering the value, press this button to transfer the dimming value for the ECG.
	Use these buttons to brighten/darken the selected ECG in each case incrementally by approx. 1/20 (5%).
? (Entry/display field)	This field shows the current dimming value [in percent] after the "Read value" button was pressed. A dimming value (in percent) can also be entered in this field. You then press the "Set value" button to accept the dimming value and send it to the selected device.
 Read value	This button triggers a readout of the ECG's current dimming value status and shows it here.
 Function test	This button is used to perform a function test (brief flashing) for emergency lights with single battery (Device type 1).

07 B0 KNX / DALI Gateway Twin N 141/31 983D11
 07 B0 KNX / DALI Gateway Twin plus N 141/21 983411
 07 B0 KNX / DALI Gateway plus N 141/03 983711

Individual ECGs and groups can be switched directly after commissioning for testing or dimmed to a variable value without any need for bus telegrams to be sent via group addresses.

These buttons can be used to execute the following additional functions for the color temperature.

Button
 Set value
After entering the value, press this button to transfer the color temperature value for the ECG.
 / 
Use these buttons to dim the selected ECG warmer/colder in 200K increments.
? (Entry/display field)
This field shows the current color temperature value (in Kelvin) after the "Read value" button was pressed. A color temperature value (in Kelvin) can also be entered in this field. You then press the "Set value" button to apply the value and send it to the selected device.
 Read value
This button triggers a readout of the ECG's current color temperature value status and shows it here.

07 B0 KNX / DALI Gateway Twin N 141/31 983D11
 07 B0 KNX / DALI Gateway Twin plus N 141/21 983411
 07 B0 KNX / DALI Gateway plus N 141/03 983711

22.3 Scenes

New Delete Copy Paste Read scene values								
Name	Scene number	Dimming time	A,G1: Group 1	A,G2: Group 2	B,G1: Gruppe 1	A,G3: Group 3	A,G4: Group 4	
Scene 1	1	0,7sec	0 %	0 %	-	0 %	0 %	
Scene 2	2	0,7sec	10 %	-	-	-	-	
Scene 3	3	0,7sec	-	10 %	-	-	10 %	
Scene 4	4	0,7sec	0 %	20 %	-	-	-	
Scene 5	5	0,7sec	3 %	60 %	-	-	-	
Scene 6	6	0,7sec	20 %	20 %	-	30 %	0 %	
Scene 7	7	0,7sec	-	-	-	-	-	
Scene 8	8	0,7sec	-	-	-	-	-	
Scene 9	9	0,7sec	-	-	-	-	-	
Scene 10	10	0,7sec	-	-	-	-	-	
Scene 11	11	0,7sec	-	-	-	-	-	
Scene 12	12	0,7sec	-	-	-	-	-	
Scene 13	13	0,7sec	-	-	-	-	-	
Scene 14	14	0,7sec	-	-	-	-	-	

Fig. 43 Scene test parameters window

After selecting a list entry, the following functions can be executed via the buttons.

Button
All ECGs ON This button switches on all ECGs ("Central On" for all ECGs).
All ECGs OFF This button switches off all ECGs ("Central Off" for all ECGs).
Read scene values This button is used to read and display the current dimming and color temperature values for all groups and ECGs.
<input checked="" type="checkbox"/> Set value (call up) This button calls up the selected scene. The integrated groups set the dimming and color temperature values stored in the gateway.
<input type="checkbox"/> Read values This button is used to read and display the current dimming and color temperature values for all groups and ECGs. This is how to set a scene on site using control elements and then read it back into the configuration. The values read can be changed in the configuration before saving or downloading them.

Individual scenes can be tested directly after assigning the ECG and a download parameter, without any need to send bus telegrams via group addresses.

22.4 Effects

The effects can be tested in this parameter window. Each individual effect can be tested independently. In this test are KNX telegrams are transferred so all other KNX devices through the effects will be activated.

The following buttons are available:

Selection Effect	Each individual effect can be tested independently. This menu is used to select the current effect.
Status Effect	Current status of the selected effect: - running - stopped - ...
Cycles	Here are the runs of the individual effects is counted. This is of interest if only a certain number of passes has been parameterized.
START - Step - Pause - Stop	These functions are used to control the current effect.
Factor	Using this factor, the effect of time up to 10 times faster.
All stop	This stops all effects.

07 B0 KNX / DALI Gateway Twin N 141/31 983D11
 07 B0 KNX / DALI Gateway Twin plus N 141/21 983411
 07 B0 KNX / DALI Gateway plus N 141/03 983711

Effects									
Effect 1		Running	cycle 1	START	1	Step	Pause	Stop	All stop
No.	Effect channel	Value	Dimming time	Delay					
1	Effect channel 2	50	-	00:00:01					
2	Effect channel 1	50	-	00:00:01					
3	Effect channel 3	50	-	00:00:01					
4	Effect channel 1	50	-	00:00:01					
5	Effect channel 5	50	-	00:00:01					
6	Effect channel 1	0	-	00:00:01					

Fig. 44 Test Effects

07 B0 KNX / DALI Gateway Twin N 141/31 983D11
 07 B0 KNX / DALI Gateway Twin plus N 141/21 983411
 07 B0 KNX / DALI Gateway plus N 141/03 983711

23. Settings

23.1 Works function

The Works function is enabled ex works:

- Broadcast mode
- KNX buttons ex works control both channels and switch or dim all connected ECGs (switching, dimming).
- A DALI Button interface in the delivered state controls both channels.
- Other sensors are not included.

23.2 Acknowledge

All group telegrams, even those sent personally, are confirmed in the standard setting.

General	
System	
Parameter	Settings
Optimized acknowledge	Yes No
Yes: Group telegram repetitions are avoided if group addresses are solely used to connect internal function blocks.	

23.3 Behavior during Download

On starting a download (programming) the following actions are executed:

- End of all effects
- End of all time functions
- Stop of all light controllers
- Saving of the current statuses of all ECGs

No commands are processed during the download:

- DALI sensor events are discarded
- Group telegrams are discarded
- Controllers are disabled
- Emergency mode cannot be enabled

If there is a power failure during a download:

- DALI failure
- ECGs switch to "System Failure Level" if the supply is backed up
- The application is not started after the mains power is restored. The download process must be repeated in its entirety.

After a complete download, the behavior is as after a mains failure. In addition, all undefined ECG status values are 0.

Behavior after the partial download is variable:

General	
System	
Parameter	Settings
Behavior after partial download	ECG off, controllers disabled ECG on, controllers enabled As before download
This parameter sets the behavior after a partial download: "ECG off, controllers disabled": All groups are switched off and all controllers are disabled. "ECG on, controllers enabled": All groups are switched on and all controllers are enabled. "As before download": All groups that are unaffected by the parameters remain unchanged. In other words, these revert to their former values after the partial download. Groups that are affected by changes can change their dimming values. All controls are restored to reflect the enabling before the download. Time functions continue to run in timer mode or in night mode.	

07 B0 KNX / DALI Gateway Twin N 141/31 983D11 07 B0 KNX / DALI Gateway Twin plus N 141/21 983411 07 B0 KNX / DALI Gateway plus N 141/03 983711
--

The following actions are executed after the download:

- Set the dimming values in accordance with the parameter setting.
- Controllers are restarted in accordance with the parameter setting.
- The timer functions continue. If they have expired during the download, then the next step will be executed.
- Timer functions are updated in accordance with the parameter setting.
- The "Block failure status messages" object is reset. The failure messages are reactivated.

07 B0 KNX / DALI Gateway Twin N 141/31 983D11
 07 B0 KNX / DALI Gateway Twin plus N 141/21 983411
 07 B0 KNX / DALI Gateway plus N 141/03 983711

24. Behavior during power failure/recovery

Should there be a (mains) power failure, the device saves the current dimming and color temperature values for all groups, so that these are available again when the power is restored. Depending on the configuration, groups can assume different dimming and color temperature values when there is a power failure.

Note: The standard configuration for a power failure is "No action", for power recovery it is "As before bus voltage failure".

The dimming value or color temperature value, which is set on power recovery, is variable by means of parameters. To avoid high bus loads on the KNX bus (to transfer the current group status messages when the bus voltage recovers), you can set a delay time, with status messages being transferred only after this has elapsed (→ 24.1).

24.1 Parameter

General	
Behavior during ramp-up and failure	
Parameter	Settings
Delay after restart [mm:ss]	00:00 AM – 04:15 00:00
If objects should be sent on the bus after bus voltage recovery, this can be delayed by means of this parameter. This avoids the occurrence of bus overloads if a number of gateways are in use. If several gateways are installed, these should be set to different delay values. This parameter refers to the following communication objects (→ Sec. 0): [Channel], status failure [Channel], DALI device failure (minimum delay dependent on the number of DALI subscribers) [Channel], [Group / ECG], status switching [Channel], [Group / ECG], status dimming value [Channel], [group / ECG], status color temperature [Channel], [Group / ECG], status failure	
Optimize DALI communication after return of power supply	No Yes
Some DALI ECGs need a pause in the DALI communication after the power supply is recovered. This is enabled by setting the parameter to "Yes".	

07 B0 KNX / DALI Gateway Twin N 141/31 983D11
 07 B0 KNX / DALI Gateway Twin plus N 141/21 983411
 07 B0 KNX / DALI Gateway plus N 141/03 983711

24.2 Objects - Failure status

Depending on the configuration and the type of event, the objects "Power failure", "[Channel], DALI device failure" and "[Channel], DALI short circuit" are sent on a corresponding failure.

Event	"DALI, status failure" parameter	Power failure	[Channel], DALI device failure	[Channel], DALI short circuit
Power supply, failure	Send only on read request	-	-	-
	Send on status change	X	-	-
	Send on status change/bus voltage recovery	X	-	-
Power, Recovery (= Ramp-up)	Send only on read request	-	-	-
	Send on status change	X	-	-
	Send on status change/bus voltage recovery	X	X	X
DALI short circuit, begin	Send only on read request	-	-	-
	Send on status change	-	-	X
	Send on status change/bus voltage recovery	-	-	X
DALI short circuit, end	Send only on read request	-	-	-
	Send on status change	-	-	X
	Send on status change/bus voltage recovery	-	-	X
DALI devices, failure	Send only on read request	-	-	-
	Send on status change	-	X	-
	Send on status change/bus voltage recovery	-	X	-
DALI devices, recovery	Send only on read request	-	-	-
	Send on status change	-	X	-
	Send on status change/bus voltage recovery	-	X	-
KNX bus voltage, failure	Send only on read request	-	-	-
	Send on status change	-	-	-
	Send on status change/bus voltage recovery	-	-	-
KNX bus voltage, recovery	Send only on read request	-	-	-
	Send on status change	-	-	-
	Send on status change/bus voltage recovery	X	X	X

X = Object is sent, - = Object is not sent

07 B0 KNX / DALI Gateway Twin N 141/31 983D11
 07 B0 KNX / DALI Gateway Twin plus N 141/21 983411
 07 B0 KNX / DALI Gateway plus N 141/03 983711

24.3 Group/ECG

24.3.1 Power failure

The description of the ECG's behavior without checking by the gateway is for information only. There may be deviations owing to incorrect or different implementation with individual ECGs

Dimming behavior:

Mode	Parameter setting	Switch on value	Dimming value during emergency lighting	Power failure (gateway) DALI short circuit (gateway)	KNX bus voltage, failure
Normal mode	No action			No action	
	Switch on value	Dimming value at switch off		Set maximum dimming value (no time limit)	If the lamp was switched on, cancel dimming; otherwise set to the dimming value on switch off with no time limit, if there is no value, set to the minimum dimming value.
		Last received dimming value		Set maximum dimming value (no time limit)	Set to the last received dimming value with no time limit or, if there is no value or zero was the last value received, set to the minimum dimming value.
		Dimming value x%		Set value to x% (no time limit)	
	Maximum dimming value			Set maximum dimming value (no time limit)	
	Minimum dimming value			Set minimum dimming value (no time limit)	
	Dimming value for emergency lighting		No change	No action. Value as before power failure	
			Value x%	Set value to x% (no time limit)	
Switch off			Switch off		
Timer mode / Night mode	No action			No action. Status as before power failure, time limiting remains enabled. If the time elapses during the failure or if the failure is the 230V AC supply, the lamp remains on with no time limit until the DALI short circuit has been cleared and the gateway sends the value no value to the ECG.	No action. Status as before power failure, time limiting remains enabled. If the time elapses during the failure, the lamp is switched accordingly.
	Switch on value	Dimming value at switch off		Set maximum dimming value (no time limit)	If the lamp was switched on during the failure, cancel dimming; otherwise set to the dimming value on switch off with no time limit or, if there is no value, set to the minimum dimming value.

07 B0 KNX / DALI Gateway Twin N 141/31 983D11
 07 B0 KNX / DALI Gateway Twin plus N 141/21 983411
 07 B0 KNX / DALI Gateway plus N 141/03 983711

		Last received dimming value		Set maximum dimming value (no time limit)	Set to the last received dimming value with no time limit or, if there is no value or zero was the last value received, set to the minimum dimming value.	
		Dimming value x%		Set value to x% (no time limit)		
		Maximum dimming value			Set maximum dimming value (no time limit)	
		Minimum dimming value			Set minimum dimming value (no time limit)	
		Dimming value for emergency lighting		No change	Status as before power failure, time limiting remains enabled. If the time elapses during the failure or if the failure is the 230V AC supply, the lamp remains on with no time limit until the DALI short circuit has been cleared and the gateway sends the value no value to the ECG.	Status as before power failure, time limiting remains active; if the time expires during the failure, then the lamp is switched accordingly.
				Value x%	Set value to x% (no time limit)	
	Switch off			Switch off		
Mode	Parameter setting	Switch on value	Dimming value during emergency lighting	DALI failure (ECG) (System Failure Level)	ECG 230V (supply) failure	
Normal mode/Timer mode/Night mode	No action			No action	For ECG emergency lighting: The device goes into emergency lighting mode For normal ECG: Light failure	
	Switch on value	Dimming value at switch off		Set maximum dimming value (no time limit)		
		Last received dimming value		Set maximum dimming value (no time limit)		
		Dimming value x%		Set value to x% (no time limit)		
	Maximum dimming value			Set maximum dimming value (no time limit)		
	Minimum dimming value			Set minimum dimming value (no time limit)		
	Dimming value for emergency lighting		No change	No action		
			Value x%	Set value to x% (no time limit)		
Switch off			Switch off			

07 B0 KNX / DALI Gateway Twin N 141/31 983D11
 07 B0 KNX / DALI Gateway Twin plus N 141/21 983411
 07 B0 KNX / DALI Gateway plus N 141/03 983711

Color temperature:

Mode	Parameter setting	Switch on value	Color temperature in emergency mode	Power failure (gateway) DALI short circuit (gateway)	KNX bus voltage, failure	
Normal mode/Timer mode/Night mode	No action			No action		
	Switch on value	Color temperature value during switch off		Set maximum color temperature value	Set to the color temperature value during switch off or, if there is no such value, do not change the current color temperature.	
		Last received color temperature value		Set maximum color temperature value	Set to the last received color temperature value or, if zero was the last value received, set to the minimum dimming value. If no value is available, the current color temperature is not changed.	
		Color temperature value x %		Set value to x (K)		
	Color temperature value for emergency lighting		No change	No action. Value as before power failure		
			Value x%	Set value to x (K)		
	According to parameter			Set value to x (K)		
Mode	Parameter setting	Switch on value	Color temperature in emergency mode	Dali (ECG) failure (System Failure Level)	ECG 230V (supply) failure	
Normal mode/Timer mode/Night mode	No action			No action		
	Switch on value	Color temperature value during switch off		Set maximum color temperature value	For ECG emergency lighting: The device goes into emergency lighting mode For normal ECG: Light failure	
		Last received color temperature value		Set maximum color temperature value		

07 B0 KNX / DALI Gateway Twin N 141/31 983D11
 07 B0 KNX / DALI Gateway Twin plus N 141/21 983411
 07 B0 KNX / DALI Gateway plus N 141/03 983711

Mode	Parameter setting	Switch on value	Color temperature in emergency mode	Dali (ECG) failure (System Failure Level)	ECG 230V (supply) failure
		Color temperature value x %		Set value to x (K)	
	Color temperature value for emergency lighting		No change	No action	
			Value x%	Set value to x (K)	
	According to parameter			Set value to x (K)	

24.3.2 Power recovery

Dimming behavior:

Mode	Parameter setting	Switch on value	Power, gateway recovery*)	KNX bus voltage, recovery/ DALI short circuit, End (gateway)
Normal mode	No action		No action	
	Switch on value	Dimming value at switch off	Set to maximum (no time limit)	If the lamp was switched on during the failure, recover the value; otherwise set to the dimming value on switch off with no time limit or, if there is no value, set to the minimum dimming value.

07 B0 KNX / DALI Gateway Twin N 141/31 983D11
 07 B0 KNX / DALI Gateway Twin plus N 141/21 983411
 07 B0 KNX / DALI Gateway plus N 141/03 983711

		Last received dimming value	Set to maximum (no time limit)	Set to the last received dimming value with no time limit or, if there is no value or zero was the last value received, set to the minimum dimming value.
		Dimming value x%	Set value to x% (no time limit)	
	Maximum dimming value		Set to maximum (no time limit)	
	Minimum dimming value		Set to minimum (no time limit)	
	as before the bus voltage failure		Value as before power failure	
	Last received dimming value		Set to maximum (no time limit)	Set to the last received dimming value with no time limit or, if there is no value or zero was the last value received, set to the minimum dimming value.
	Switch off		Switch off	
Timer mode / Night mode	No action		No action	
	Switch on value	Dimming value at switch off	Set to maximum (time limit)	If the lamp was switched on during the failure, recover the value (time limit); otherwise set to the dimming value on switch off with no time limit or, if there is no value, set to the minimum dimming value (time limited).
		Last received dimming value	Set to maximum (time limit)	Set to the last received dimming value, time limited or, if there is no value or zero was the last value received, set to the minimum dimming value (time limited).
		Dimming value x%	Set to the configured switch on value (time limited)	
	Maximum dimming value		Set to maximum (time limit)	
	Minimum dimming value		Set to minimum (time limit)	
	as before the bus voltage failure		Status as before voltage failure (time limited if On)	
	Last dimming value		Set to maximum (time limit)	Set to the last received dimming value, time limited or, if there is no value or zero was the last value received, set to the minimum dimming value (time limited).
	Switch off		Switch off	

*) on recovery of the 230V AC supply, ECGs are switched to night mode with no time limit

If the power supply for the ECGs is recovered before that for the gateway, the ECGs start with their own configuration. The current DALI standard does not record which value is used as the start value if no DALI power is available when starting the ECG.

The start value is therefore produced from the sequence in the ECG and the "DALI failure - ECG" and "Power Recovery (ECG)" table.

If the gateway has concluded the start process, the ECG is controlled using the "Gateway Power Recovery" table.

The description of the ECG's behavior without checking by the gateway is for information only. There may be deviations owing to different implementation of individual ECGs

07 B0 KNX / DALI Gateway Twin N 141/31 983D11
 07 B0 KNX / DALI Gateway Twin plus N 141/21 983411
 07 B0 KNX / DALI Gateway plus N 141/03 983711

Mode	Parameter setting	Switch on value	Power, Recovery (ECG) (Power On Value)	DALI recovery (ECG)
ECG is in stand-by area	---	---	Switch off	The gateway tracks the ECG using the current valid value.
Normal mode/Timer mode/Night mode	No action		No action	
	Switch on value	Dimming value at switch off	Set maximum dimming value (no time limit)	
		Last received dimming value	Set maximum dimming value (no time limit)	
		Dimming value x%	Set value to x% (no time limit)	
	Maximum dimming value		Set maximum dimming value (no time limit)	
	Minimum dimming value		Set minimum dimming value (no time limit)	
	As before bus voltage failure		No action	
	Last dimming value		Set maximum dimming value (no time limit)	
	Switch off		Switch off	

If the connection to the ECG is broken, the ECG is reported as faulty. If the connection is recovered, the ECG is tracked with the currently valid value.

07 B0 KNX / DALI Gateway Twin N 141/31 983D11
 07 B0 KNX / DALI Gateway Twin plus N 141/21 983411
 07 B0 KNX / DALI Gateway plus N 141/03 983711

Color temperature:

Mode	Parameter setting	Switch on value	Power, gateway recovery*)	KNX bus voltage, recovery / DALI short circuit, end (gateway)
Normal mode/timer mode/night mode	No action		No action	
	Switch on value	Color temperature value during switch off	Set to max. color temperature value	Set to the color temperature value during switch off or, if there is no such value, do not change the current color temperature.
		Last received color temperature value	Set to max. color temperature value	Set to the last received color temperature value or, if zero was the last value received, set to the minimum dimming value. If no value is available, the current color temperature is not changed.
		Color temperature value x %	Set value to x (K)	
	As before bus voltage failure		Value as before power failure	
	Last received color temperature value		Set to max. color temperature value	Set to the last received color temperature value or, if zero was the last value received, set to the minimum dimming value. If no value is available, the current color temperature is not changed
	According to parameter		Set value to x (K)	

If the power supply for the ECGs is recovered before that for the gateway, the ECGs start with their own configuration. The current DALI standard does not record which value is used as the start value if no DALI power is available when starting the ECG. The start value is therefore determined by the sequence in the ECG and the "DALI failure (ECG)" and "Power, recovery (ECG)" table. If the gateway has concluded the start process, the ECG is controlled using the "Gateway Power Recovery" table.

The description of the ECG's behavior without checking by the gateway is for information only. There may be deviations owing to different implementation of individual ECGs.

07 B0 KNX / DALI Gateway Twin N 141/31 983D11
 07 B0 KNX / DALI Gateway Twin plus N 141/21 983411
 07 B0 KNX / DALI Gateway plus N 141/03 983711

Mode	Parameter setting	Power-on mode	Power, recovery (ECG) (Power On Value)	DALI recovery (ECG)
Normal mode/Timer mode/Night mode	No action		No action	The gateway tracks the ECG using the current valid value.
	Switch on value	Color temperature value during switch off	Set maximum color temperature value	
		Last received color temperature value	Set maximum color temperature value	
		Color temperature value x %	Set value to x (K)	
	As before bus voltage failure		No action	
	Last received color temperature value		Set maximum color temperature value	
	According to parameter		Set value to x (K)	

If the connection to the ECG is broken, the ECG is reported as faulty. If the connection is restored, the ECG is tracked with the currently valid value.

24.4 Sensors

No special actions are executed here.

24.5 2-point controller/Constant light control

If the mains power or the KNX bus voltage fails, the implementation of the light controllers is stopped. The status is Off following recovery; the controllers are thus deactivated. A DALI failure has no effect.

24.6 Timer functions

If the mains power or the KNX bus voltage fails, the execution of the time commands is stopped. They are then later executed when the power returns. A DALI failure does not directly affect the timer functions.

07 B0 KNX / DALI Gateway Twin N 141/31 983D11
 07 B0 KNX / DALI Gateway Twin plus N 141/21 983411
 07 B0 KNX / DALI Gateway plus N 141/03 983711

25. Standard applications

The device provides various standard applications which are functional without KNX connection. They are used as an "island solution" if no KNX communication is provided or is not supplemented until later. If the functionality of the standard applications does not suffice for the usage case, then the individual start-up with ETS is recommended.

The standard applications all operate with central commands (broadcast) so that no identification of the ECG is necessary. It is possible to have more than one DALI pushbutton interface, but only to have one DALI motion detector per channel.

If the mode is activated or changed, then the devices on the DALI bus will be partially reconfigured. This also means that an existing configuration by the bus is lost. The bus mode can only be reactivated by a new download.

ECG failures (lights or ECG defective) are recognized; they are displayed for each channel. No support is available for emergency lights.

The prior status before the failure is restored when the power fails.

If a DALI device is added, the mode must be re-selected to configure the new device. The same applies if a defective ECG or defective sensor is repaired or replaced.

25.1.1 Configuration

The various standard applications are stored in the device as a configuration and can be called up and configured by the operating buttons and the device display. The device is restarted (reset) following the selection of the standard application whereby all of the settings in the device and in the ECGs and sensors are deleted. The selected standard application is read from the device memory and the existing sensors searched for following the reset. The ECGs are controlled solely by central commands (broadcast). Depending on the mode selected, the sensors and links are changed in the way described by the mode. Identical sensor types are assigned identical functions.

The behavior corresponds to a predefined ETS configuration without the need for a download. The required group addresses are assigned in the address area of the "construction site addresses" (31.7.x).

If a KNX link is connected in this mode, then the group addresses are also transferred by KNX. The KNX communication is not deactivated.

Function	Group address
A, Switching	31/7/0
A, Dimming	31/7/1
A, Dimming value	31/7/2
A, Status for motion detectors	31/7/3
B, Switching	31/7/16
B, Dimming	31/7/17
B, Dimming value	31/7/18
B, Status for motion detectors	31/7/19
Scene call-up	31/7/32
A, Brightness	31/7/48
B, Brightness	31/7/49
A, Save target value	31/7/50
B, Save target value	31/7/51
A, Dimming value status	31/7/52
B, Dimming value status	31/7/53

07 B0 KNX / DALI Gateway Twin N 141/31 983D11
 07 B0 KNX / DALI Gateway Twin plus N 141/21 983411
 07 B0 KNX / DALI Gateway plus N 141/03 983711

25.1.2 Activate standard applications

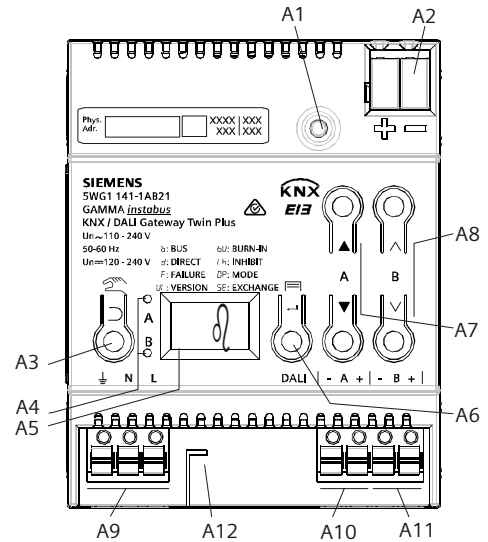

Fig. 46 Gateway control and display elements

- A1 Programming button with LED (red)
Programming mode: Briefly pressing and releasing the programming button (< 0.5 s) activates the programming mode. This is displayed by flashing of the programming LED.
Factory settings: Pressing and holding down the programming button for a prolonged time period (> 20 s) restores the device to its factory settings. This is displayed by uniform flashing of the programming LED. The flashing stops after 5 s.
Note: No functions are executed when the programming button is held down for a longer period of time (> 0.5 s to 2 s). The device can be blocked for programming mode for approx. 10 s. This is displayed by brief flashing of the programming LED.
- A2 Connector for KNX terminal
- A3 Button when pressed
 Briefly: "back" ↩
 Held down: Direct mode 📶
- A4 These two LEDs are used to display information about the respective channel.
- A5 Device information display
- A6 Button when pressed
 "OK" ← or Menu 📄
- A7 Button pair ▲ ▼ for menu control or direct operation of channel A
- A8 Button pair ↶ ↷ submenu control or direction operation of channel B
- A9 Terminals for earthing, neutral and phase conductors (L, N, earth)
- A10 Terminal pair for DALI channel A
- A10 Terminal pair for DALI channel B
- A12 Stripping template (stamping)

07 B0 KNX / DALI Gateway Twin N 141/31 983D11
 07 B0 KNX / DALI Gateway Twin plus N 141/21 983411
 07 B0 KNX / DALI Gateway plus N 141/03 983711

Button	Display	Description
A6 ☰		Switch to menu with A6
A7 ▲▼	○ DP ○	After multiple pressing of the A7 menu item "Standard applications"
A6 (briefly) ←	○ AD ○	The last mode selected is displayed when A6 is tapped.
A6 (long) ←	○ AD (blinks)	The display switches to selection mode when A6 is held down.
A7 ▲▼	○ AS (blinks)	The mode can be selected when A7 is pressed. The display flashes during the mode configuration.
A6 ←	○ t1 ○	(flashes) The following parameters can be set in certain modes by holding down A6: t1 : Time delay t1 [min] (Standard value 15) t2 : Time delay t2 [min] (Standard value th = 60) d1 : Dimming value d1 [%] (Standard30) LL : Brightness threshold L1 - L5 (Standard L3) All of the parameters are confirmed by tapping A6.
A3 ↶		Pressing A3 "back" restores the previous settings, if applicable.
A6 ←	○ A1 ○	(flashes) Holding down A6 confirms the selection and restarts the device.
A6 ←	○ Co ○	The devices are configured after the device is restarted.
	A	(flashes) Failures are displayed after the configuration as follows: E0 : DALI short circuit E1 : No sensors found E2 : No button interface found E3 : Not enough channels found for button interface (button interface defective) E4 : No presence sensor found E5 : Too many presence sensors found E6 :Not enough channels found for presence sensors (Combination sensor defective) E7 : Configuration failure E8 – E9 : reserved for additional failures The LED thus shows whether the failure occurred on Channel A and/or B. Failures can be confirmed by A6.

07 B0 KNX / DALI Gateway Twin N 141/31 983D11
 07 B0 KNX / DALI Gateway Twin plus N 141/21 983411
 07 B0 KNX / DALI Gateway plus N 141/03 983711

Button	Display	Description
		The "A" display is shown when the standard application is active.

25.1.3 Description

25.1.3.1 Mode A0 – Base function

This mode is used as a standard setting in the device and functions without configuration. The plug-and-play function of the sensors and ECGs is used for this purpose. The plug-and-play function results in all system devices needing to be reset. This is the same as the building site function. KNX buttons, in the delivery state, control both channels and the switching/dimming all connected ECGs (switching, dimming).

Display: 

Motion/brightness sensor:
not used.

25.1.3.2 Mode A1 – Manual mode A

In mode A1, both lines can be separated, and switched or dimmed by all buttons. The channel to which the button sensors are connected is irrelevant here. Scenes are effective across the channels and can be saved by holding down a button (> 0,5s). The current values of Channel A or B are saved as a scene value. The scene values are retained when the bus voltage fails/returns.

Default Scene 1 50%/50% (Eco);
 Default Scene 2 0%/0%; (Centrally OFF);

Display: 

Button assignment:

DALI Button interfaces – Channel A	DALI Button interfaces – Channel B								
A=One-button dimming – Channel A	A=One-button dimming – Channel A								
B=One-button dimming – Channel B	B=One-button dimming – Channel B								
C=Scene 1 (affects A+B)	C=Scene 1 (affects A+B)								
D=Scene 2 (affects A+B)	D=Scene 2 (affects A+B)								
<table border="1" style="margin: auto;"> <tr> <td style="text-align: center;">ON ↑</td> <td style="text-align: center;">S1</td> </tr> <tr> <td style="text-align: center;">↓ OFF</td> <td style="text-align: center;">S2</td> </tr> </table>	ON ↑	S1	↓ OFF	S2	<table border="1" style="margin: auto;"> <tr> <td style="text-align: center;">ON ↑</td> <td style="text-align: center;">S1</td> </tr> <tr> <td style="text-align: center;">↓ OFF</td> <td style="text-align: center;">S2</td> </tr> </table>	ON ↑	S1	↓ OFF	S2
ON ↑	S1								
↓ OFF	S2								
ON ↑	S1								
↓ OFF	S2								

Motion/brightness sensor:
not used.

07 B0 KNX / DALI Gateway Twin N 141/31 983D11
 07 B0 KNX / DALI Gateway Twin plus N 141/21 983411
 07 B0 KNX / DALI Gateway plus N 141/03 983711

25.1.3.3 Mode A2 – Manual mode B

In Mode A2, channels A and B can be separately controlled on the respective channel of the connected button sensors. A "two-button dimmer" is configured in the button interface at input A/B for this operation of the entire channel. Input C calls up a scene from the respective channel. Input D controls both DALI lines.

The scenes can be saved by holding down a button (> 0,5s). The current values of Channel A or B are saved as a scene value. The scene values are retained when the bus voltage fails/returns.

- Default Scene 1 50% (Eco channel A);
- Default Scene 2 50% (Eco channel B);
- Default Scene 3 0%/0%; (Centrally OFF);

Display:  assignment:

DALI Button interfaces – Channel A	DALI Button interfaces – Channel B								
A=ON/Brighter – Channel A	A=ON/Brighter – Channel B								
B=Off/Darker – Channel A	B=Off/Darker – Channel B								
C=Scene 1 (affects A only)	C=Scene 2 (affects B only)								
D=Scene 3 (affects A+B)	D=Scene 3 (affects A+B)								
<table border="1" style="margin: auto; border-collapse: collapse;"> <tr> <td style="padding: 5px;">ON ↑</td> <td style="padding: 5px;">S1</td> </tr> <tr> <td style="padding: 5px;">↓ OFF</td> <td style="padding: 5px;">S3</td> </tr> </table>	ON ↑	S1	↓ OFF	S3	<table border="1" style="margin: auto; border-collapse: collapse;"> <tr> <td style="padding: 5px;">ON ↑</td> <td style="padding: 5px;">S2</td> </tr> <tr> <td style="padding: 5px;">↓ OFF</td> <td style="padding: 5px;">S3</td> </tr> </table>	ON ↑	S2	↓ OFF	S3
ON ↑	S1								
↓ OFF	S3								
ON ↑	S2								
↓ OFF	S3								

Motion/brightness sensor:
not used.

07 B0 KNX / DALI Gateway Twin N 141/31 983D11
 07 B0 KNX / DALI Gateway Twin plus N 141/21 983411
 07 B0 KNX / DALI Gateway plus N 141/03 983711

25.1.3.4 Mode A3 - manual mode with delay time

Mode A3 is based on Mode A2. The difference lies in the fact that the delay time T1 of the respective DALI channel is automatically restarted. No shut-down occurs following T1 after a scene is called up.

Display: 

Button assignment:

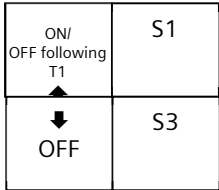
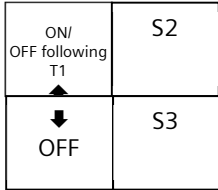
DALI Button interfaces – Channel A	DALI Button interfaces – Channel B
A=On/Brighter – Channel A Auto OFF following T1	A=On/Brighter – Channel B Auto OFF following T1
B=Off/Darker – Channel A	B=Off/Darker – Channel B
C=Scene 1 (affects A only)	C=Scene 2 (affects B only)
D=Scene 3 (affects A+B)	D=Scene 3 (affects A+B)
	

Motion/brightness sensor:
not used.

Adjustable:

T1 in min	0(∞)...15 ...99 min
-----------	---------------------

Switching diagram:

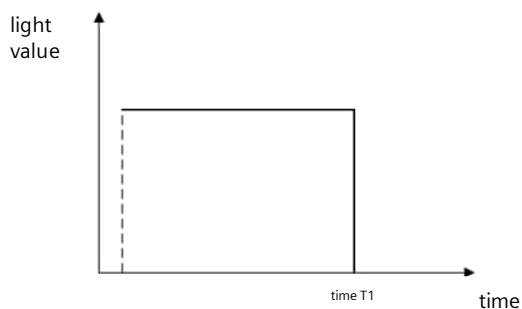

07 B0 KNX / DALI Gateway Twin N 141/31 983D11
 07 B0 KNX / DALI Gateway Twin plus N 141/21 983411
 07 B0 KNX / DALI Gateway plus N 141/03 983711

25.1.3.5 Mode A4 – manual mode with delay time, 2-stage

Mode A4 is based on Mode A2. The shut-down occurs in 2 stages with time delay. Dimming to the dimming value d1% occurs in the first stage following the delay time T1. Shut-down occurs following delay time T2. No shut-down occurs following T1 + T2 after a scene is called up.

Display: 

Button assignment:

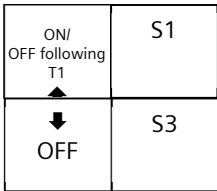
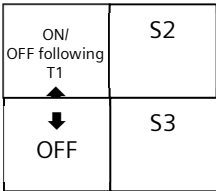
DALI Button interfaces – Channel A	DALI Button interfaces – Channel B
A=On/Brighter – Channel A Following T1 Auto to d1% Following T2 Auto Off	A=ON/Brighter – Channel B Following T1 Auto to 30% Following T2 Auto OFF
B=Off/Darker – Channel A	B=Off/Darker – Channel B
C=Scene 1 (affects A only)	C=Scene 2 (affects B only)
D=Scene 3 (affects A+B)	D=Scene 3 (affects A+B)
	

Motion/brightness sensor:
not used.

Adjustable:

T1 in min	0(∞)...15 ...99min
T2 in min or h	0(∞)...60min → 1h...9h
d1 in %	0...10...100 % (100% = max. dimming value)

Switching diagram:

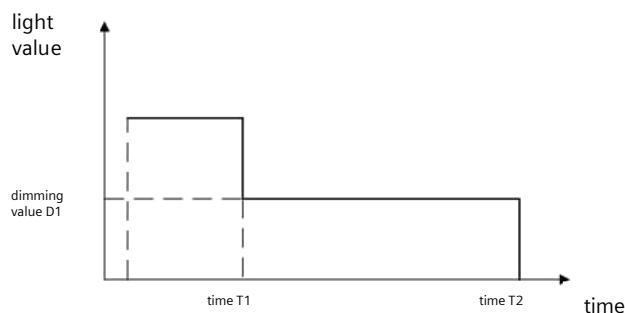

07 B0 KNX / DALI Gateway Twin N 141/31 983D11
 07 B0 KNX / DALI Gateway Twin plus N 141/21 983411
 07 B0 KNX / DALI Gateway plus N 141/03 983711

25.1.3.6 Mode A5 - Off, depending on presence

Mode A5 is based on Mode A2. The input A button interface is used for switch-on. The presence detector shuts off when the motion ends and following the T1 delay time. Manual shut-down by Input B is immediately possible. The button interfaces used are configured in Mode A2. Only one presence sensor may be connected for the presence.

Display: 

Button assignment:

DALI Button interfaces – Channel A	DALI Button interfaces – Channel B								
A=On /Brighter – Channel A	A=On /Brighter – Channel B								
B=Off / Darker – Channel A	B=Off / Darker – Channel B								
C=Scene 1 (affects A only)	C=Scene 2 (affects B only)								
D=Scene 3 (affects A+B)	D=Scene 3 (affects A+B)								
<table border="1" style="margin: auto;"> <tr> <td style="text-align: center;">ON/ Auto ↑</td> <td style="text-align: center;">S1</td> </tr> <tr> <td style="text-align: center;">↓ OFF</td> <td style="text-align: center;">S3</td> </tr> </table>	ON/ Auto ↑	S1	↓ OFF	S3	<table border="1" style="margin: auto;"> <tr> <td style="text-align: center;">ON/ Auto ↑</td> <td style="text-align: center;">S2</td> </tr> <tr> <td style="text-align: center;">↓ OFF</td> <td style="text-align: center;">S3</td> </tr> </table>	ON/ Auto ↑	S2	↓ OFF	S3
ON/ Auto ↑	S1								
↓ OFF	S3								
ON/ Auto ↑	S2								
↓ OFF	S3								

Motion/brightness sensor:

DALI presence detectors – Channel A	DALI presence detectors – Channel B
PIR - OFF only following T1 (0%) – Channel A	PIR - OFF only following T1 (0%) – Channel B

Adjustable:

Parameter	Settings
T1 in min	0(∞)...15 ...99 min

07 B0 KNX / DALI Gateway Twin N 141/31 983D11
 07 B0 KNX / DALI Gateway Twin plus N 141/21 983411
 07 B0 KNX / DALI Gateway plus N 141/03 983711

25.1.3.7 Mode A6 – Dependent on presence

Mode A6 is based on Mode A5. Activation is additionally caused by the presence detector when motion is detected. The motion detection is only active up to a certain room brightness. The correction factor for the measured brightness (calibration factor) can be set by LL (Light Level) in 5 stages (L1 = 0.5, L2 = 1, L3 = 2, L4 = 3, L5 = 10). The greater the calibration factor, the lower the brightness threshold at which the presence detector switches on. If this is not the case, then it will neither be switched on nor switched off following the time T1. It is also possible to use buttons to switch the presence detector on/off. Only one presence sensor may be connected for the presence.

Display: 

Button assignment:

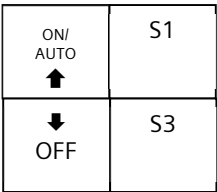
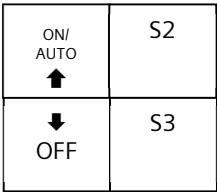
DALI Button interfaces – Channel A	DALI Button interfaces – Channel B
A=On /Brighter – Channel A	A=ON/Brighter – Channel B
B=Off / Darker – Channel A	B=Off / Darker – Channel B
C=Scene 1 (affects A only)	C=Scene 2 (affects B only)
D=Scene 3 (affects A+B)	D=Scene 3 (affects A+B)
	

Motion/brightness sensor:

DALI motion detectors – Channel A	DALI motion detectors – Channel B
PIR - ON (100%) - Channel A	PIR - ON only (100%) - Channel B
PIR - following time T1 – OFF	PIR - following time T1 – OFF

Adjustable:

Parameter	Settings
T1 in min	0(∞)...15 ...99 min
LL in Level	L1 = 0.5, L2 = 1, L3 = 2, L4 = 3, L5 = 10

Switching diagram:

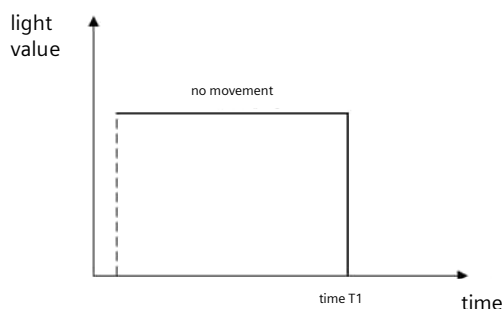

07 B0 KNX / DALI Gateway Twin N 141/31 983D11
 07 B0 KNX / DALI Gateway Twin plus N 141/21 983411
 07 B0 KNX / DALI Gateway plus N 141/03 983711

25.1.3.8 Mode A7 - presence-dependent Off, 2-stage

Mode A7 is based on Mode A5. The shut-down additionally occurs in 2 stages. At the end of the motion detection and expiration of the delay time T1, dimming occurs to dimming value d1% followed by shut-down after T2 expires. If motion is detected in the ongoing time, then the process is restarted. The motion detection is only active up to a certain room brightness. The correction factor for the measured brightness (calibration factor) can be set by LL (Light Level) in 5 stages (L1 = 0.5, L2 = 1, L3 = 2, L4 = 3, L5 = 10). The greater the calibration factor, the lower the brightness threshold at which the presence detector switches on. If this is not the case, then it will neither be switched on nor switched off. Only one presence sensor may be connected for the presence.

Display: 

Button assignment:

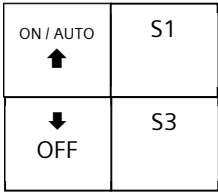
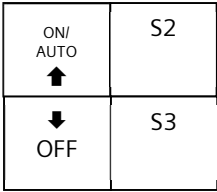
DALI Button interfaces – Channel A	DALI Button interfaces – Channel B
A=On /Brighter – Channel A	A=ON/Brighter – Channel B
B=Off / Darker – Channel A	B=Off / Darker – Channel B
C=Scene 1 (affects A only)	C=Scene 2 (affects B only)
D=Scene 3 (affects A+B)	D=Scene 3 (affects A+B)
	

Motion/brightness sensor:

DALI presence detectors – Channel A	DALI presence detectors – Channel B
PIR - to d1% following time T1	PIR - to d1% following time T1
PIR - off following time T2	PIR - off following time T2

Adjustable:

Parameter	Settings
T1 in min	0(∞)...15 ...99min
T2 in min or h	0(∞)...60 min -> 1h...9h
d1 in %	0...10...100 %
LL in Level	L1 = 0.5, L2 = 1, L3 = 2, L4 = 3, L5 = 10

Switching diagram:

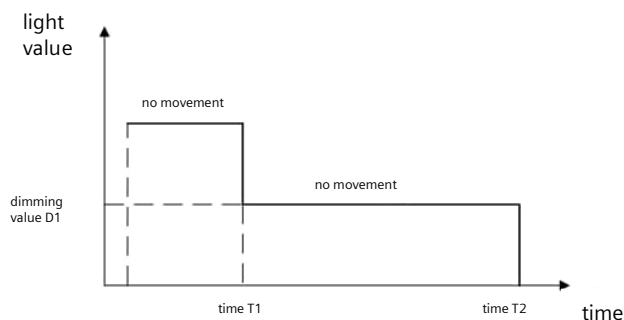

07 B0 KNX / DALI Gateway Twin N 141/31 983D11
 07 B0 KNX / DALI Gateway Twin plus N 141/21 983411
 07 B0 KNX / DALI Gateway plus N 141/03 983711

25.1.3.9 Mode A8 - Semiautomatic constant light control

Mode A8 uses the constant light controller as a semiautomatic system. In this process, input A of the controller's button interface is activated and the channel switched on or dimmed brighter. The controller is deactivated with input B and the DALI channel switched off or dimmed darker. An individual brightness value for the constant light control can be set by brighter/darker dimming, whereby the controller is deactivated. The individual brightness value can be saved as a new target value for the constant light controller by double-clicking on one of the two inputs. The controller must be reactivated by Input A after saving. The additional inputs can be used to control scenes in a manner similar to that of Mode A2. The DALI channel is shut off at the end of the motion detection and following the delay time T1. When it is switched on again by Input A, the controller switches on and dims to the required dimming value. The correction factor for the measured brightness (calibration factor) can be set by LL (Light Level) in 5 stages (L1 = 0.5, L2 = 1, L3 = 2, L4 = 3, L5 = 10). The greater the calibration factor, the lower the brightness threshold at which the presence detector switches on. If this is not the case, then it will neither be switched on nor switched off. The constant light controller is deactivated following brighter/darker or the call-up of a scene. Only one presence sensor may be connected for the presence.

Display: 

Button assignment:

DALI Button interfaces – Channel A	DALI Button interfaces – Channel B								
A=Controller 1 ON button held down= A Brighter button tapped= A ON button pressed twice=Save target value	A=Controller 2 ON button held down= B Brighter button tapped= B On button pressed twice=Save target value								
B=Controller 1 OFF button held down= A Darker button tapped= Switch A OFF button pressed twice=Save target value	B=Controller 1 OFF button held down= B Darker button tapped= Switch B OFF button pressed twice=Save target value								
C=Scene 1 (affects A only)	C=Scene 2 (affects B only)								
D=Scene 3 (affects A+B)	D=Scene 3 (affects A+B)								
<table border="1" style="margin: auto;"> <tr> <td style="text-align: center;">AUTO ↑</td> <td style="text-align: center;">S1</td> </tr> <tr> <td style="text-align: center;">↓ OFF</td> <td style="text-align: center;">S3</td> </tr> </table>	AUTO ↑	S1	↓ OFF	S3	<table border="1" style="margin: auto;"> <tr> <td style="text-align: center;">AUTO ↑</td> <td style="text-align: center;">S2</td> </tr> <tr> <td style="text-align: center;">↓ OFF</td> <td style="text-align: center;">S3</td> </tr> </table>	AUTO ↑	S2	↓ OFF	S3
AUTO ↑	S1								
↓ OFF	S3								
AUTO ↑	S2								
↓ OFF	S3								

Motion/brightness sensor:

DALI presence detectors – Channel A	DALI presence detectors – Channel B
PIR – OFF only following time T1 - Channel A	PIR – OFF only following time T1 - Channel B

Adjustable:

Parameter	Settings
T1 in min	0(∞)...15 ...99min
LL in Level	L1 = 0.5, L2 = 1, L3 = 2, L4 = 3, L5 = 10

07 B0 KNX / DALI Gateway Twin N 141/31 983D11
07 B0 KNX / DALI Gateway Twin plus N 141/21 983411
07 B0 KNX / DALI Gateway plus N 141/03 983711

Switching diagram:

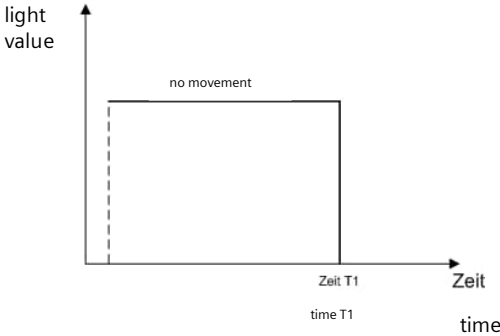

07 B0 KNX / DALI Gateway Twin N 141/31 983D11
 07 B0 KNX / DALI Gateway Twin plus N 141/21 983411
 07 B0 KNX / DALI Gateway plus N 141/03 983711

25.1.3.10 Mode A9 - Fully automatic constant light controller

Mode A8 uses the constant light controller as a fully automatic system. In this process, input A of the controller's button interface is activated and the channel switched on or dimmed brighter. The controller is deactivated with input B and the DALI channel switched off or dimmed darker. An individual brightness value for the constant light control can be set by brighter/darker dimming, whereby the controller is deactivated. The individual brightness value can be saved as a new target value for the constant light controller by double-clicking on one of the two inputs. The controller must be reactivated by Input A after saving. The additional inputs can be used to control scenes in a manner similar to that of Mode A2. The DALI channel is shut off at the end of the motion detection and following the delay time T1. The presence sensor switches on when motion is detected again and the controller dims to the required dimming value. The motion detection is only active up to a certain room brightness. The correction factor for the measured brightness (calibration factor) can be set by LL (Light Level) in 5 stages (L1 = 0.5, L2 = 1, L3 = 2, L4 = 3, L5 = 10). The greater the calibration factor, the lower the brightness threshold at which the presence detector switches on. If this is not the case, then it will neither be switched on nor switched off. The constant light controller is deactivated following brighter/darker or the call-up of a scene. Only one presence sensor may be connected for the presence.

Display: 

Button assignment:

DALI Button interfaces – Channel A	DALI Button interfaces – Channel B								
A=Controller 1 ON button held down= A Brighter button tapped= A ON button pressed twice=Save target value	A=Controller 2 ON button held down= B Brighter button tapped= B ON button pressed twice=Save target value								
B=Controller 1 OFF button held down= A Darker button tapped= Switch A OFF button pressed twice=Save target value	B=Controller 2 OFF button held down= B Darker button tapped= B OFF button pressed twice=Save target value								
C=Scene 1 (affects A only)	C=Scene 2 (affects B only)								
D=Scene 3 (affects A+B)	D=Scene 3 (affects A+B)								
<table border="1"> <tr> <td>AUTO ↑</td> <td>S1 (50%)</td> </tr> <tr> <td>↓ OFF</td> <td>S3</td> </tr> </table>	AUTO ↑	S1 (50%)	↓ OFF	S3	<table border="1"> <tr> <td>AUTO ↑</td> <td>S2</td> </tr> <tr> <td>↓ OFF</td> <td>S3</td> </tr> </table>	AUTO ↑	S2	↓ OFF	S3
AUTO ↑	S1 (50%)								
↓ OFF	S3								
AUTO ↑	S2								
↓ OFF	S3								

Motion/brightness sensor:

DALI presence detectors – Channel A	DALI presence detectors – Channel B
PIR - ON only (100%) - Channel A	PIR - ON only (100%) - Channel B
Off following time T1	Off following time T1

Adjustable:

Parameter	Settings
T1 in min	0(∞)...15 ...99min
LL in Level	L1 = 0.5, L2 = 1, L3 = 2, L4 = 3, L5 = 10

07 B0 KNX / DALI Gateway Twin N 141/31 983D11
07 B0 KNX / DALI Gateway Twin plus N 141/21 983411
07 B0 KNX / DALI Gateway plus N 141/03 983711

Switching diagram:

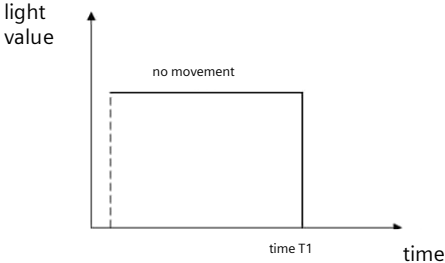

07 B0 KNX / DALI Gateway Twin N 141/31 983D11
 07 B0 KNX / DALI Gateway Twin plus N 141/21 983411
 07 B0 KNX / DALI Gateway plus N 141/03 983711

26. Annexes

26.1 DALI dimming curve

The adaptation of the DALI dimming curve to the sensitivity of the human eye results in a logarithmic characteristic curve for the luminous flux, which is detected by human perception as a linear light progression.

IEC 62386-102 describes the DALI values as "ARC Power across the light source", which in most cases forms a nearly linear correlation with the luminous flux.

The luminous flux describes the entire light output emitted from a light source in all room directions. This unit is Lumen (lm).

The characteristic curve in the following illustration was determined for the DALI luminous flux.

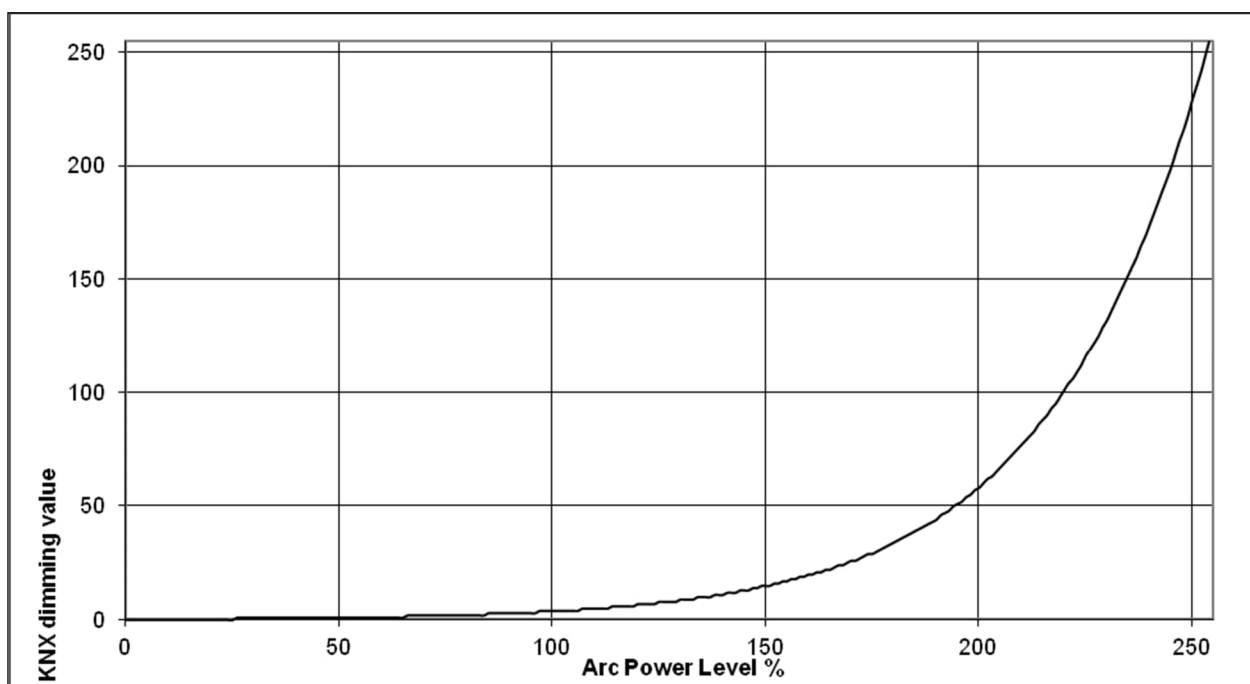

Fig. 47 KNX - DALI - Dimming curve

26.2 Color temperature control

The color temperature control is defined in standard DALI IEC 62386, in chapter 209 "Color Control." The ECG is defined as device type 8. Device type 8 refers to color controllable lights. The color temperature is measured in Kelvin (K).

The DALI gateway can control the color temperature and brightness of ECG of device type 8.

The device can be used in human-centric lighting application because it can control the color temperature of a DALI LED from warm white to cold white ("tunable white").

Human-centric lighting (HCL) expands the concept of biologically effective lighting with holistic planning and covers the visual, emotional and biological effects of light. HCL supports human health, well-being and performance in the long-term.

The following table shows the color temperature values of different sources of light:

07 B0 KNX / DALI Gateway Twin N 141/31 983D11
 07 B0 KNX / DALI Gateway Twin plus N 141/21 983411
 07 B0 KNX / DALI Gateway plus N 141/03 983711

Color temperature	Light source
1000 – 1500 K	Candle
2600 K	Incandescent lamp (40 W)
2700 – 2800 K	Halogen lamp (230 V, eco-halogen, 30 – 60 W)
3000 K	Incandescent lamp (200 W)
3000 – 3200 K	Halogen lamp (12 V)
3600 K	Operating theater lighting
4000 K	Fluorescent lamps (neutral white)
4120 K	Moonlight
5000 K	Morning/evening sun
5500 K	Mid-morning/afternoon sun
5500 – 5600 K	Electronic flash device
5500 – 5800 K	Mid-day sun, clouds
6500 – 7500 K	Cloudy sky
7500 – 8500 K	Fog, significant smog
9000 – 12000 K	Blue (cloudless) sky on the shady north side, blue hour
15000 – 20000 K	Clear, blue, northern light

Fig. 45 Color temperature values and light source

The following table shows how the human body perceives the different color temperatures:

Color temperature	Associated effect:
2700 K	Ambient, intimate
3000 K	Calm, warm
3500 K	Friendly, inviting
4100 K	Precise, clean, efficient
5000 K	Daylight, dynamic
6500 K	Daylight, attentive

Fig. 46 Color temperature values and associated effect

26.3 Troubleshooting

In the commissioning of DALI installations can cause problems. DALI is a very robust communications system. It is possible that DALI devices not found and lights are not activated. The causes are varied and rich of errors in the installation to thermal problems in the light or in the ECG.

07 B0 KNX / DALI Gateway Twin N 141/31 983D11
 07 B0 KNX / DALI Gateway Twin plus N 141/21 983411
 07 B0 KNX / DALI Gateway plus N 141/03 983711

All the mechanisms put a reliable communication between PlugIn, device and DALI ECG advance. The device searches for the automatic commissioning after the first existing DALI devices with DALI short address and read the parameters (RND/random number/long address/device type/CIN/min. Dimming value). DALI ECG without DALI short address are free DALI short addresses assigned. This DALI short addresses that are already assigned to the PlugIn are not re-used.

If duplicate DALI short addresses will be attempted addressing with the help of the random number and remap the conflict automatically dissolve. If more than 64 found EVG breaks the device commissioning.

Using the PlugIn can all DALI devices collectively or individually in the factory reset.

In many cases, these are installation errors, such as incorrect cable cross-sections and cable lengths for DALI installations. In order for the error in the installation, it is recommended to isolate the affected lights by activation of the PlugIn to isolate and locate. Also a separating the DALI line and step-by-step connecting individual DALI ECG can help with troubleshooting.

You can obtain information and support here:
<http://www.siemens.com/supportrequest>

26.3.1 Communication failure

While the PlugIn in the ETS is open, data are continuously between the PlugIn and the device via KNX replaced. Should the communication error, e.g. by too high a KNX bus load between the PlugIn and the device, the following error message is displayed:



Fig. 47 Communication failure

In this case the KNX connection between the PC and the device to check:

- KNX power supply
- KNX/DALI power supply
- KNX interface (local physical address of the KNX interface)
- KNX routing via couplers
- KNX bus load

Possible problem solutions

- Restart ETS
- Disconnect the KNX/DALI gateway from other KNX devices in order to reduce the bus load.

26.3.2 Too many DALI ECG found

Reason	Solution
--------	----------

07 B0 KNX / DALI Gateway Twin N 141/31 983D11 07 B0 KNX / DALI Gateway Twin plus N 141/21 983411 07 B0 KNX / DALI Gateway plus N 141/03 983711
--

More than 64 ECG to the DALI line connected	Maximum number of connected EVG on 64 Pieces reduced.
No DALI short addresses more free	Check if already assigned EVG separately. Check setting menu option: Do not use already assigned short addresses.

07 B0 KNX / DALI Gateway Twin N 141/31 983D11 07 B0 KNX / DALI Gateway Twin plus N 141/21 983411 07 B0 KNX / DALI Gateway plus N 141/03 983711
--

26.3.3 PlugIn displays failure

In the parameter window commissioning errors are indicated by red lines are selected.

- Select line with ECG ON-OFF-FLASHING CONTROL to ECG with conflicts to identify.
 - Only one ECG is flashing
 - Problem in installation, cable length or ECG (Hardware),
 - More ECG are flashing
 - Solve conflict by Reset & Init → Search ECG → still failure?

No: → Problem in installation, cable length or ECG (Hardware)